



中国认可
国际互认
检测
TESTING
CNAS L0220

Test Report issued under the responsibility of:



TEST REPORT
NRS 097-2-1:2017
GRID INTERCONNECTION OF EMBEDDED GENERATION
PART 2: SMALL-SCALE EMBEDDED GENERATION
SECTION 1: UTILITY INTERFACE

Report Reference No......: 190624070GZU-001
Date of issue: 23 Aug 2019
Total number of pages.....: 66 pages

Testing Laboratory Intertek Testing Services Shenzhen Ltd. Guangzhou Branch
Address..... Block E, No.7-2 Guang Dong Software Science Park, Caipin Road,
Guangzhou Science City, GETDD, Guangzhou, China
Testing location/ address..... Same as above
Tested by (name + signature)..... Jason Fu
Technical Team Leader
Approved by (+ signature) Tommy Zhong
Technical Manager

Applicant's name ShenZhen Lux Power technology Co.,LTD
Address..... Room 403,4th Floor, Building 63, ZhongwuNew Industrial Park, Zhongwu
Community, Hangcheng Street, Baoan District, Shenzhen, China

Test specification:
Standard NRS 097-2-1:2017
Test procedure..... Type approval
Non-standard test method..... N/A

Test Report Form No. NRS 097-2-1a
Test Report Form(s) Originator..... Intertek Guangzhou
Master TRF Dated 2019-05

This publication may be reproduced in whole or in part for non-commercial purposes as long as Intertek is acknowledged as copyright owner and source of the material. Intertek takes no responsibility for and will not assume liability for damages resulting from the reader's interpretation of the reproduced material due to its placement and context.

Test item description Hybrid Inverter
Trade Mark 
Manufacturer..... Same as Applicant
Model/Type reference LXP 3K Hybrid, LXP 4K Hybrid, LXP 5K Hybrid

Ratings	Model	LXP 3K Hybrid	LXP 4K Hybrid	LXP 5K Hybrid
Max. PV Input Voltage	550V			
Max. PV current	10A/10A	11A/11A	11A/11A	
Max. PV Isc	12.5A/12.5A	13.7A/13.7A	13.7A/13.7A	
Battery Type	Lead-acid, Lithium-ion			
Battery Voltage Range	40-60V			
Max. Charging and discharging Current	66A			
Max. Charging & Discharging Power	3600W			
Nominal Grid voltage	230V			
Nominal Output Voltage (backup)	230V			
Max. Input & output current	15A	20A	25A	
Nominal Frequency	50Hz			
Power Factor	1 (adjustable +/-0.8)			
Nominal Input & output power	3000W	4000W	5000W	
EPS Rated current	13A			
Backup Rated Apparent Power	EPS			
Ingress Protection	IP 65			
Protective Class	Class I			
Operating temperature range	-25 ~ +60°C			
FW Version	AA1.0			

Summary of testing:	
Tests performed (name of test and test clause):	
NRS 097-2-1	Test Description
4.1.2 & 4.1.9	Normal voltage operating range Normal frequency operating range
4.1.5	Flicker and voltage changes
4.1.7	Commutation notches
4.1.8	DC injection
4.1.10	Harmonics and waveform distortion
4.1.11	Power factor
4.1.12 & 4.2.4	Synchronization Response to utility recovery
4.1.13*	Electromagnetic compatibility (EMC)
4.2.2.3.2	Overvoltage and undervoltage
4.2.2.3.3	Over-frequency and under-frequency
4.2.2.4	Prevention of islanding
<p>Remark:</p> <p>For all clauses, the model LXP 5K Hybrid is type tested.</p> <p>For clause 4.1.8, the models LXP 5K Hybrid and LXP 3K Hybrid are type tested.</p> <p>For clause 4.1.10, all models are type tested.</p> <p>*refer to report No.ES 190816020E, tested and issued by EMTEK (SHENZHEN) CO., LTD, dated 16 Aug 2019</p>	
Testing location:	
<p>Intertek Testing Services Shenzhen Ltd. Guangzhou Branch</p> <p>Block E, No.7-2 Guang Dong Software Science Park, Caipin Road, Guangzhou Science City, GETDD, Guangzhou, China</p>	

Copy of marking plate

LU X POWER^{TEK}	
Hybrid inverter	
Model	LXP-5K Hybrid
Max.DC voltage	550V
MPP voltage range	120---500V
Max.DC short current(input A/input B)	13.7A/13.7A
Max.DC current(input A/input B)	11A/11A
Max.DC power	8000W
Nominal AC voltage,Frequency	230V~ ,50/60Hz
Max.continuous AC current	25A
Nominal AC power(@cosΦ =1)	5000W
Power factor at rated power	1
Adjustable displacement factor range	0.8 leading... 0.8 lagging
AC input nominal voltage,Frequency	230V~ ,50/60Hz
AC input max.continuous current	25A
AC input nominal power	5000W
Z_source (ohm)	1.05+j0.32
Max. AC short-circuit current	21.8A
Battery type	Lead-acid/Lithium
EPS nominal voltage,Frequency	230V~ ,50/60Hz
EPS nominal output power	3000W
EPS nominal current	13A
Battery voltage operation voltage	40---60V
Max.charge and discharge current	66A
Max.charge and discharge power	3600W
Operating ambient temperature range	-25---60°C
Ingress protection	IP65 (Outdoor use)
Protective class	I
Over voltage category	III
Certificates and approvals	A54777/VDE-AR-N4105 VDE0126/G83/G59/CEI 0-21

Note:

1. The above markings are the minimum requirements required by the safety standard. For the final production samples, the additional markings which do not give rise to misunderstanding may be added.
2. Label is attached on the side surface of enclosure and visible after installation
3. The other model labels are identical with label above, except the model name and rating.

Test item particulars	
Temperature range	-25 ~ +60°C
AC Overvoltage category	<input type="checkbox"/> OVC I <input type="checkbox"/> OVC II <input checked="" type="checkbox"/> OVC III <input type="checkbox"/> OVC IV
DC Overvoltage category	<input type="checkbox"/> OVC I <input checked="" type="checkbox"/> OVC II <input type="checkbox"/> OVC III <input type="checkbox"/> OVC IV
IP protection class	IP 65
Possible test case verdicts:	
- test case does not apply to the test object	: N/A (Not applicable)
- test object does meet the requirement.....	: P (Pass)
- test object does not meet the requirement.....	: F (Fail)
Testing	
Date of receipt of test item	: 03 Jun 2019
Date (s) of performance of tests	: 03 Jun 2019 – 16 Aug 2019
General remarks:	
<p>The test results presented in this report relate only to the object tested. This report shall not be reproduced, except in full, without the written approval of the Issuing testing laboratory. "(see Enclosure #)" refers to additional information appended to the report. "(see appended table)" refers to a table appended to the report.</p> <p>When determining for test conclusion, measurement uncertainty of tests has been considered. This report is for the exclusive use of Intertek's Client and is provided pursuant to the agreement between Intertek and its Client. Intertek's responsibility and liability are limited to the terms and conditions of the agreement. Intertek assumes no liability to any party, other than to the Client in accordance with the agreement, for any loss, expense or damage occasioned by the use of this report. Only the Client is authorized to permit copying or distribution of this report and then only in its entirety. Any use of the Intertek name or one of its marks for the sale or advertisement of the tested material, product or service must first be approved in writing by Intertek. The observations and test results in this report are relevant only to the sample tested. This report by itself does not imply that the material, product, or service is or has ever been under an Intertek certification program. The test report only allows to be revised only within the report defined retention period unless standard or regulation was withdrawn or invalid.</p> <p>Throughout this report a point is used as the decimal separator.</p>	
Factory information:	
Shenzhen Sea Star Industry Co.,LTD Bao Long 6th Avenue Sea Star Science Park,6th Floor Long Gang Street,Bao Long Industrial City, Long Gang District, Shenzhen, China	

General product information:

The Solar Inverter converts DC voltage into AC voltage.

The input and output are protected by varistors to Earth. The unit is providing EMC filtering at the PV input and output toward mains. The unit does not provide galvanic separation from input to output (transformerless type). The output is switched off redundantly by the high power switching bridge and two relays. This assures that the opening of the output circuit will also operate in case of a single error.

The internal control is redundant built. It consists of Microcontroller Main DSP (U21) and RCU MCU(U1).

The Main DSP(U21) control the relays by switching signals; measures the PV voltage, PV current, Bus voltage, grid voltage, frequency, AC current with injected DC and the array insulation resistance to ground. In addition it tests the current sensors and the RCMU circuit before each start up.

The RCU MCU (U1) is measures the grid voltage, AC current, grid frequency and residual current, also can switch off the relays independently, and communicate with Main DSP (U21) each other.

The current is measured by a current sensor. The AC current signal and the injected DC current signal are sent to the Main DSP(U21). The Main DSP(U21) tests and calibrates before each start up all current sensors.

The unit provides two relays in series in all output conductors. When single fault applied to one relay, alarm an error code in display panel, another redundant relay provides basic insulation maintained between the PV array and the mains. All the relays are tested before each start up.

The topology diagram as following:

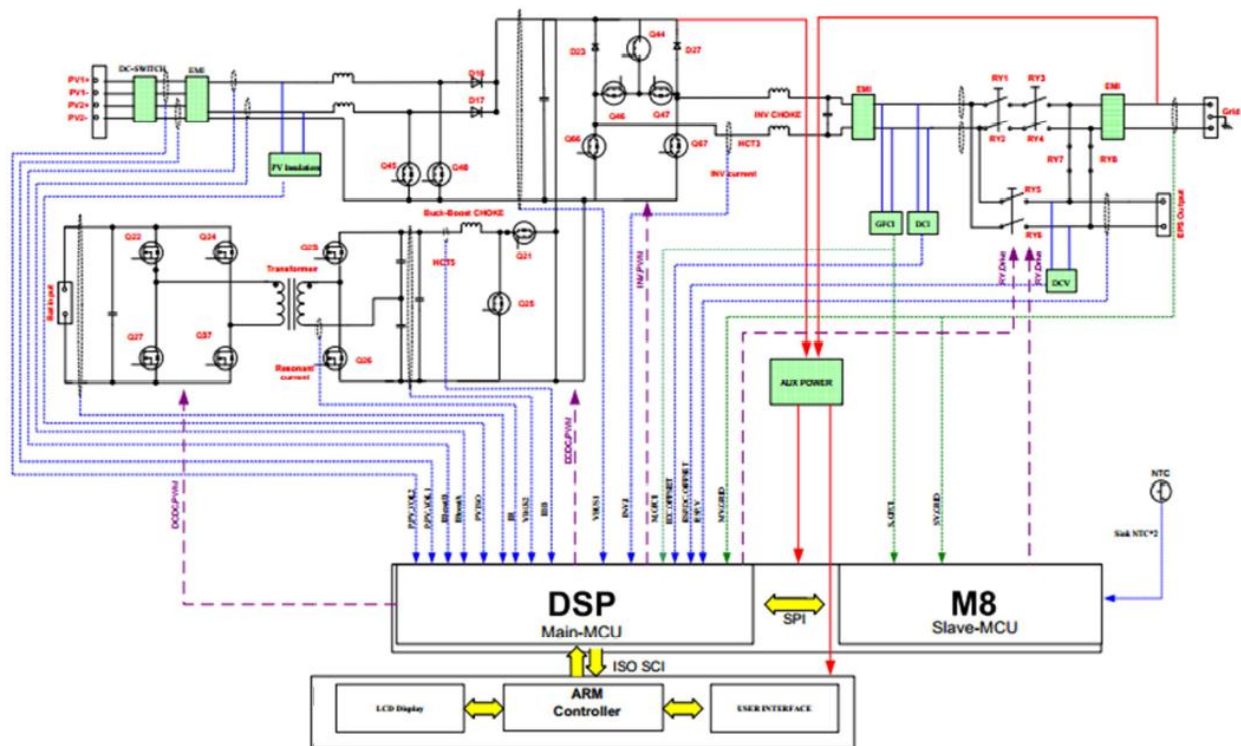

Figure 1 – Block diagram

Model differences:

The models LXP 3K Hybrid, LXP 4K Hybrid and LXP 5K Hybrid are completely identical and output power derating in software,

The reference impedance: $Z_{source} = 1,05 + j 0,32 \text{ ohm}$, i.e. $I_{SC} = 210 \text{ A}$

NRS 097-2-1:2017			
Clause	Requirement - Test	Result - Remark	Verdict
4	Requirements		P
4.1	Utility compatibility (Performance aspects)		P
4.1.1	General		P
4.1.1.1	This clause describes the technical issues and the responsibilities related to interconnecting an embedded generator to a utility network.		P
4.1.1.2	The quality of power provided by the embedded generator in the case of the on-site a.c. loads and the power delivered to the utility is governed by practices and standards on voltage, flicker, frequency, harmonics and power factor. Deviation from these standards represents out-ofbounds conditions. The embedded generator is required to sense the deviation and might need to disconnect from the utility network.		P
4.1.1.3	All power quality parameters (voltage, flicker, frequency and harmonics) shall be measured at the POC, unless otherwise specified (see annex A). The power quality to be supplied to customers and influenced by SSEG shall comply with NRS 048-2. This implies that the combined voltage disturbances caused by the specific EG and other customers, added to normal background voltage disturbances, may not exceed levels stipulated by NRS 048-2. The maximum emission levels that may be contributed by SSEG are provided in this document (see 4.1.5 to 4.1.10). The customer can expect power quality at the POC in line with NRS 048-2. As such, the generator may not contribute significant disturbances to the voltage supplied at the POC. Typical contributions for small customer installations (total installation) are provided in Annex D of NRS 048-4.		P
4.1.1.4	The embedded generator's a.c. voltage, current and frequency shall be compatible with the utility at the POC.		P
4.1.1.5	The embedded generator shall be type approved, unless otherwise agreed upon with the utility (see annex A).		P
4.1.1.6	The maximum size of the embedded generator is limited by the rating of the supply point on the premises.		N/A
4.1.1.7	The utility will approve the size of the embedded generator and will decide on the connection point and conditions. In some cases it may be required to create a separate supply point.		N/A
4.1.1.8	Embedded generators larger than 13,8 kVA shall be of the balanced three-phase type unless only a single-phase network supply is available, in which case NRS 097-2-3 recommendations can be applied based on the NMD.	Single-phase	N/A

NRS 097-2-1:2017			
Clause	Requirement - Test	Result - Remark	Verdict
4.1.1.9	A customer with a multiphase connection shall split the embedded generator in a balanced manner over all phases if the EG is larger than 4,6 kVA.		N/A
4.1.1.10	Embedded generators or generator systems larger than 100 kVA may have additional requirements, for example, they must be able to receive communication signals for ceasing generation/disconnection from the utility supply, if the utility requires such. Communication facilities shall be provided to utility at no charge for integration with SCADA or other system when required. See Annex G (G.1).		N/A
4.1.1.11	In line with the current Renewable Power Plant Grid Code, embedded generators smaller than 1000 kVA connected to low-voltage form part of Category A generators, with the following subcategories: a) Category A1: 0 – 13,8 kVA; This sub-category includes RPPs of Category A with rated power in the range from 0 to 13,8 kVA, inclusive of 13,8 kVA. b) Category A2: 13,8 kVA – 100 kVA; and This sub-category includes RPPs of Category A with rated power in the range greater than 13,8 kVA but less than 100 kVA. c) Category A3: 100 kVA – 1 MVA. This sub-category includes RPPs of Category A with rated power in the range from 100 kVA but less than 1 MVA.		P
4.1.1.12	In accordance with SANS 10142-1, all generators shall be wired permanently.		P
4.1.1.13	Any UPS/generating device that operates in parallel with the grid may only connect to the grid when it complies fully with the requirements of this part of NRS 097. This includes UPS configurations with or without EG.		P
4.1.1.14	Standby-generators are covered by SANS 10142-1.		N/A
4.1.1.15	All generators larger than 100 kVA will be controllable, i.e. be able to control the active output power dependent on network conditions/abnormal conditions. This includes several smaller units that totals more than 100 kVA at a single POC.		P
4.1.1.16	Maximum DC Voltage may not exceed 1000V. This is the voltage on the DC side of the inverter, for example when no load is taken and maximum source energy is provided, e.g. peak solar radiation occurs on the solar panels.		P

NRS 097-2-1:2017			
Clause	Requirement - Test	Result - Remark	Verdict
4.1.2	Normal voltage operating range		P
4.1.2.1	In accordance with IEC 61727, utility-interconnected embedded generators do not normally regulate voltage, they inject current into the utility. Therefore the voltage operating range for embedded generators is designed as protection which responds to abnormal utility network conditions and not as a voltage regulation function.		P
4.1.2.2	The embedded generator shall synchronize (see 4.1.12) with the utility network before a connection is established. The embedded generator shall not control the voltage, unless agreed to by the utility (see annex A).		P
4.1.2.3	An embedded generator that operates in parallel with the utility system shall operate within the voltage trip limits defined in 4.2.2.3.2.		P
4.1.3	Reference source impedance and short-circuit levels (fault levels)		P
4.1.3.1	The impact of the generator on the network voltage and quality of supply levels is directly linked to the (complex) source impedance and short-circuit level. The minimum short-circuit level to which a generator can be connected should be based on the size of the generator as well as the design criteria.	Inverter type: 1 time of rated current	P
4.1.3.2	For general purposes of testing and design for potential worst-case conditions, a minimum network strength of the following may be assumed: $Z_{source} = 1,05 + j 0,32 \text{ ohm}$, i.e. $I_{SC} = 210 \text{ A}$ and $S_{SC} = 146 \text{ kVA}$ (three-phase).		P
4.1.3.3	The maximum network strength will be assumed to be no more than 33 times the rated active power of the generator. The R/X ratio will be assumed between 0,33 to 3.		P
4.1.3.4	The relevant utility will advise whether equipment may be connected at other network characteristics, i.e. for weaker parts of the network.		N/A
4.1.3.5	The generator documentation and nameplate shall state the reference impedance (complex impedance) and fault level that was used for design and certification and that it is not intended to connect the generator to a network with a higher network impedance than specified for the certification.		P

NRS 097-2-1:2017			
Clause	Requirement - Test	Result - Remark	Verdict
4.1.4	General QOS requirements		N/A
4.1.4.1	Embedded generators can expect QOS levels on networks to be in line with NRS 048-2. It is expected that the embedded generator will be able to operate continuously under worst-case conditions.		N/A
4.1.4.2	Notwithstanding this, the embedded generator must protect itself from potential excursions beyond NRS 048-2 and ensure fail-safe conditions. Should the embedded generator be unable to operate according to requirements of this document for such excursions, it shall disconnect and cease generation onto the network.		N/A
4.1.5	Flicker and voltage changes		P
4.1.5.1	When connected to a network impedance equal to the reference impedance used during certification, no SSEG may generate flicker levels higher than the following: a) short-term flicker severity (Pst) = 0,35; and b) long-term flicker severity (Plt) = 0,30.	(See appended table)	P
4.1.5.2	It is anticipated that the utility will plan the connections in line with acceptable flicker limits, i.e. the ratio of the size of the generator to the network strength at the point of connection.		P
4.1.5.3	According to VDE-AR-N 4105, no generator shall be connected to a system where generation rejection (i.e. tripping of SSEG while generating at full capacity, regardless of reason) will lead to a voltage change of 3 % or more at the PCC, thereby minimising the potential to exceed rapid voltage change limits.		P
4.1.6	Voltage unbalance		N/A
4.1.6.1	Under normal circumstances, for single and dual-phase EG, the unbalanced generation may not exceed 4,6 kVA connected between any two or different phases at an installation. Units larger than 4,6 kVA will be split evenly over the available phase connections so that this can be maintained.		N/A
4.1.6.2	Three-phase generators may not contribute more than 0,2 % voltage unbalance when connected to a network with impedance equal to the reference impedance.		
4.1.7	Commutation notches		P
	The relative depth of commutation notches due to line-commutated inverters shall not exceed 5 % of nominal voltage at the POC for any operational state.	(See appended table)	P
4.1.8	DC injection		P

NRS 097-2-1:2017			
Clause	Requirement - Test	Result - Remark	Verdict
4.1.8.1	The average d.c. current injected by the embedded generator shall not exceed 0,5 % of the rated a.c. output current over any 1-minute period, into the utility a.c. interface under any operating condition.	(See appended table)	P
4.1.8.2	According to section 4.2.2.5, the generator(s) must disconnect within 500 ms when the d.c. current exceeds this value.		P
4.1.9	Normal frequency operating range		P
	An embedded generator that operates in parallel with the utility system shall operate within the frequency trip limits defined in 4.2.2.3.3.		P
4.1.10	Harmonics and waveform distortion		P
4.1.10.1	Only devices that inject low levels of current and voltage harmonics will be accepted; the higher harmonic levels increase the potential for adverse effects on connected equipment.		P
4.1.10.2	Acceptable levels of harmonic voltage and current depend upon distribution system characteristics, type of service, connected loads or apparatus, and established utility practice.		P
4.1.10.3	The embedded generator output shall have low current-distortion levels to ensure that no adverse effects are caused to other equipment connected to the utility system.		P
4.1.10.4	The harmonic and inter-harmonic current distortion shall comply with the relevant emission limits in accordance with IEC 61727, reproduced in table 1.	(See appended table)	P
4.1.10.5	The harmonic and inter-harmonic distortion applies up to 3 kHz (50th harmonic).		P
4.1.11	Power factor		P
4.1.11.1	Irrespective of the number of phases to which an embedded generator is connected, it shall comply with the power factor requirements in accordance with 4.1.11.2 to 4.1.11.12 on each phase for system normal conditions when the output power exceeds 20 % of rated active power:	(See appended table)	P

NRS 097-2-1:2017			
Clause	Requirement - Test	Result - Remark	Verdict
4.1.11.2	<p>For static power converter embedded generators and synchronous embedded generators of sub-categories A1 and A2, the power factor shall remain above 0,98 as shown in Figure 1. The embedded generator shall operate anywhere in the shaded area of figure 1.</p> <p>Figure 1 — Power factor operating requirements for SSEG categorized A1 and A2 (using the load-reference arrows system)</p>		N/A
4.1.11.3	<p>For asynchronous embedded generators of sub-categories A1 and A2, which cannot control the power factor over any range, the power factor shall reach the shaded area of figure 1 within 60 s. The power factor shall remain above 0,98 as shown in figure 1. The embedded generator shall operate anywhere in the shaded area.</p>		N/A
4.1.11.4	<p>For static power converter embedded generators and synchronous embedded generators of sub-category A3, the power factor shall remain above 0,95 as shown in Figure 2. The embedded generator shall operate anywhere in the shaded area of Figure 2.</p> <p>Figure 2 — Power factor operating requirements for SSEG categorized A3 (using the load-reference arrows system)</p>		P
4.1.11.5	<p>For asynchronous embedded generators of sub-category A3, which cannot control the power factor over any range, the power factor shall reach the shaded area of Figure 2 within 60 s. The power factor shall remain above 0,95 as shown in Figure 2. The embedded generator shall operate anywhere in the shaded area.</p>		P
4.1.11.6	<p>Where the EG is capable of controlling the power factor at the POC, the EG should improve the power factor at the POC towards unity.</p>		P
4.1.11.7	<p>Unless otherwise agreed with the utility, the standard power factor setting shall be unity for the full power output range.</p>		P

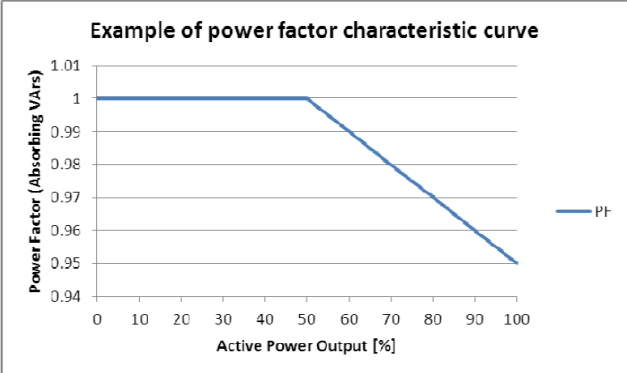
NRS 097-2-1:2017			
Clause	Requirement - Test	Result - Remark	Verdict
4.1.11.8	The maximum tolerance on the reactive power setting is 5 % of the rated active power.		P
4.1.11.9	For embedded generators of sub-category A3, the power factor shall be settable to operate according to a characteristic curve provided by the utility, if required by the utility, within the range 0,95 leading and 0,95 lagging; An example of a standard characteristic curve is shown in figure 3. 	(See appended table)	P
4.1.11.10	These limits apply, unless otherwise agreed upon with the utility (see annex A).		P
4.1.11.11	Equipment for reactive power compensation shall either: a) be connected or disconnected with the embedded generator, or b) operated via automatic control equipment for disconnection when not required.		N/A
4.1.12	Synchronization		P
4.1.12.1	All embedded generators shall synchronize with the utility network before the parallel connection is made. This applies to all embedded generators where a voltage exists at the generator terminals before connection with the utility network.		P
4.1.12.2	Automatic synchronization equipment shall be the only method of synchronization.		N/A
4.1.12.3	For a synchronous generator, the limits for the synchronizing parameters for each phase are: a) frequency difference: 0,3 Hz, b) voltage difference: 5 % of nominal voltage per phase, and c) phase angle difference: 20 ° (degrees).		N/A
4.1.12.4	Mains excited generators do not need to synchronise when the generator is started as a motor before generation starts.		N/A
4.1.12.5	Mains excited generators may require soft-starting when the start-up voltage change is anticipated to be more than 3 %.		P

NRS 097-2-1:2017			
Clause	Requirement - Test	Result - Remark	Verdict
4.1.12.6	The start-up current for static power converters shall not exceed the full-power rated current of the generator.		P
4.1.12.7	Also refer to 4.2.4 for re-synchronising conditions.		P
4.1.12.8	The embedded generator shall synchronize with the utility network only when the voltage and frequency has been stable within the ranges provided in 4.2.2.3 for at least 60 seconds.		P
4.1.13	Electromagnetic compatibility (EMC)		P
4.1.14	Mains signalling (e.g. PLC and ripple control)		N/A
4.2	Safety protection and control		P
4.2.1	<p>General</p> <p>The safe operation of the embedded generator in conjunction with the utility network shall be ensured at all times. Safe operation includes people and equipment safety, i.e.:</p> <p>a) People safety: and</p> <p>i) owner (including personnel and / or inhabitants of the property) of the embedded generator;</p> <p>ii) general public safety;</p> <p>iii) utility personnel; and</p> <p>iv) general emergency response personnel, e.g. fire brigade should a fire arise at the embedded generator.</p> <p>b) Equipment safety:</p> <p>i) utility equipment;</p> <p>ii) other customers' equipment connected to the same network(s); and</p> <p>iii) generator own equipment.</p> <p>Some of the safety aspects mentioned above may be covered in other specifications and standards and the embedded generator should ensure that safe operation is maintained at all times taking cognisance of all of the above aspects.</p> <p>Furthermore, the embedded generator owner is responsible for precautions against damage to its own equipment due to utility originating events, e.g. switching events, voltage and frequency variations, automatic reclosing onto the network etc. However, this protection may not conflict with the requirements of this specification.</p>		P
4.2.2	Safety disconnect from utility network		P
4.2.2.1	General		P

NRS 097-2-1:2017			
Clause	Requirement - Test	Result - Remark	Verdict
4.2.2.1.1	All SSEG shall comply with the safety requirements in accordance with SANS/IEC 62109-1 and IEC 62109-2.	The reports are requested by IEC 62109-1 and IEC 62109-2 that refer to report No. LD170830N034-1, tested and issued by Bureau Veritas Shenzhen Co., Ltd Dongguan Branch, dated 28 April 2018	P
4.2.2.1.2	The embedded generator shall automatically and safely disconnect from the grid in the event of an abnormal condition. Abnormal conditions include: a) network voltage or frequency out-of-bounds conditions, b) loss-of-grid conditions, c) d.c. current injection threshold exceeded (per phase), d) and residual d.c. current (phase and neutral currents summated).		P
4.2.2.2	Disconnection device (previously disconnection switching unit)		P
4.2.2.2.1	The embedded generator shall be equipped with a disconnection device, which separates the embedded generator from the grid due to abnormal conditions. The disconnection unit may be integrated into one of the components of the embedded generator (for example the PV utility interconnected inverter) or may be an independent device installed between the embedded generator and the utility interface.		P
4.2.2.2.2	The disconnection switching unit shall be able to operate under all operating conditions of the utility network.		P
4.2.2.2.3	A failure within the disconnection device shall lead to disconnection of the generator from the utility supply and indication of the failure condition.		P
4.2.2.2.4	A single failure within the disconnection switching unit shall not lead to failure to disconnect. Failures with one common cause shall be taken into account and addressed through adequate redundancy.		P
4.2.2.2.5	The disconnection device shall disconnect the generator from the network by means of two series connected robust automated load disconnect switches.		P
4.2.2.2.6	Both switches shall be electromechanical switches.		P
4.2.2.2.7	Each electromechanical switch shall disconnect the embedded generator on the neutral and the live wire(s).		P
4.2.2.2.8	All rotating generating units, e.g. synchronous or asynchronous generating units shall have adequate redundancy in accordance with 4.2.2.2.5.		P

NRS 097-2-1:2017			
Clause	Requirement - Test	Result - Remark	Verdict
4.2.2.2.9	A static power converter without simple separation shall make use of two seriesconnected electromechanical disconnection switches.		P
4.2.4.2.10	The current breaking capacity of each disconnecting switch shall be appropriately sized for the application. In cases where the disconnecting device is an electromechanical switching device such as a contactor, this requires suitable coordination with the upstream short circuit protection device (circuit breaker).		P
4.2.2.2.11	Any programmable parameters of the disconnection switching unit shall be protected from interference by third-parties, i.e. password protected or access physically sealed.		P
4.2.2.2.12	In order to allow customers to supply their own load in isolated operation (islanded) where this is feasible and required, the disconnection device may be incorporated upstream of part of or all of a customers' loads, provided that none of the network disconnection requirements in this document are violated.		N/A
4.2.2.2.13	All EG installations larger than 30 kVA shall have a central disconnection device.		N/A
4.2.2.2.14	The network and system grid protection voltage and frequency relay for the central disconnection device will be type-tested and certified on its own (stand-alone tested). All clauses of 4.2.2, except 4.2.2.4 (anti-islanding) apply.		N/A

NRS 097-2-1:2017																			
Clause	Requirement - Test	Result - Remark	Verdict																
4.2.2.3.1	<p>General</p> <p>The values in 4.2.2.3 relate to SSEG in sub-categories A1 and A2. These are kept from a historical perspective. The Grid Code requirements will override values and requirements in this category. Sub-category A3 generators shall disconnect from the network according to the RPP Grid Code for all abnormal conditions as well as stay connected in accordance with the voltage ride-through requirements of the RPP Grid Code. Abnormal conditions can arise on the utility system and requires a response from the connected embedded generator. This response is to ensure the safety of utility maintenance personnel and the general public, and also to avoid damage to connected equipment. The abnormal utility conditions of concern are voltage and frequency excursions above or below the values stated in this clause and the RPP Grid Code (section 5.2 of version 2.8). The embedded generator shall disconnect in accordance with the requirements of 4.2.2.3 if these conditions occur.</p> <p>The accuracy for voltage trip values shall be within 0 % to +1 % of the nominal voltage from the upper boundary trip setting, and within -1% to 0% of the nominal voltage from the lower boundary trip setting.</p> <p>The accuracy for frequency trip values shall be within 0 to +0,1 % of the fundamental frequency from the upper boundary trip setting, and within -0,1 % to 0 % of the fundamental frequency from the lower boundary the trip setting.</p>		P																
4.2.2.3.2	<p>Overvoltage and undervoltage</p> <p>The embedded generator in sub-category A1 and A2 shall cease to energize the utility distribution system should the network voltage deviate outside the conditions specified in table 2. The following conditions shall be met, with voltages in r.m.s. and measured at the POC.</p> <p>Table 2 — Response to abnormal voltages for SSEG in sub-categories A1 and A2</p> <table border="1"> <thead> <tr> <th>1</th> <th>2</th> </tr> </thead> <tbody> <tr> <td>Voltage range (at point of connection)</td> <td>Maximum trip time S</td> </tr> <tr> <td>V < 50 %</td> <td>0,2 s</td> </tr> <tr> <td>50 % ≤ V < 85 %</td> <td>10 s</td> </tr> <tr> <td>85 % ≤ V ≤ 110 %</td> <td>Continuous operation</td> </tr> <tr> <td>110 % < V < 115 %</td> <td>40 s</td> </tr> <tr> <td>115% ≤ V < 120%</td> <td>2 s</td> </tr> <tr> <td>120 % ≤ V</td> <td>0,16 s</td> </tr> </tbody> </table> <p>NOTE If multi-voltage control settings are not possible, the more stringent trip time should be implemented, e.g. 2 s between 110% and 120% of voltage.</p>	1	2	Voltage range (at point of connection)	Maximum trip time S	V < 50 %	0,2 s	50 % ≤ V < 85 %	10 s	85 % ≤ V ≤ 110 %	Continuous operation	110 % < V < 115 %	40 s	115% ≤ V < 120%	2 s	120 % ≤ V	0,16 s		P
1	2																		
Voltage range (at point of connection)	Maximum trip time S																		
V < 50 %	0,2 s																		
50 % ≤ V < 85 %	10 s																		
85 % ≤ V ≤ 110 %	Continuous operation																		
110 % < V < 115 %	40 s																		
115% ≤ V < 120%	2 s																		
120 % ≤ V	0,16 s																		

NRS 097-2-1:2017			
Clause	Requirement - Test	Result - Remark	Verdict

4.2.2.3.3	<p>Over-frequency and under-frequency</p> <p>This requirement is in line with the RPP Grid Code (version 2.8) and applies to all EG in category A. The embedded generation system shall cease to energize the utility network when the utility frequency deviates outside the specified conditions. Both over- and under-frequency conditions indicate system abnormal conditions and all generators are expected to assist in stabilising the system during such periods.</p> <p>When the utility frequency is less than 47 Hz, the embedded generator shall disconnect from the utility network within 0,2 s.</p> <p>While the utility frequency is in the range of 47 Hz and 50,5 Hz, the system shall operate normally.</p> <p>In order to prevent hysteresis switching (on-off toggling) during over-frequency conditions, the output power shall be reduced as follows:</p> <p>When the utility frequency exceeds 50,5 Hz, the active power available at the time shall be stored as the maximum power value PM; this value PM shall not be exceeded until the frequency has stabilised below 50,5 Hz for at least 4 seconds.</p> <p>The EG system shall control the output power as a function of PM at a gradient of 50 % per Hertz as illustrated in figure 5. The power generation shall follow the curve shown in figure 5 up and down while the system frequency is in the range 50,5 Hz to 52 Hz.</p> <p>When the utility frequency is more than 52 Hz for longer than 4 seconds, the embedded generator shall cease to energize the utility line within 0,5 s.</p>		P
-----------	---	--	---

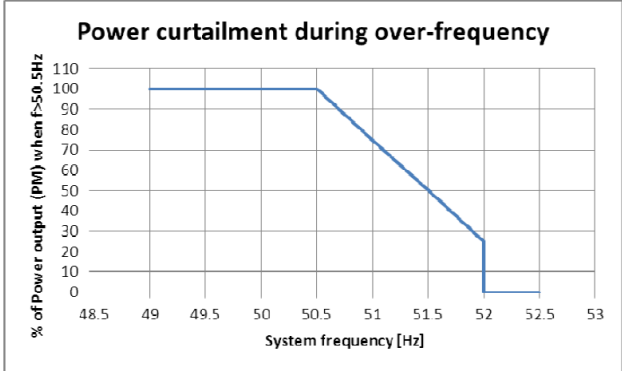

Figure 5 — Power curtailment during over-frequency

NRS 097-2-1:2017			
Clause	Requirement - Test	Result - Remark	Verdict
4.2.2.3.3.1	<p>Relaxation for non-controllable generators Non-controllable generators may disconnect randomly within the frequency range 50.5 Hz to 52 Hz. The disconnect frequency for non-controllable generators will each be set at a random value by the manufacturer, with the option of changing this to a utility provided setting. The random disconnect frequency shall be selected so that all generators from any specific manufacturer will disconnect uniformly over the range with 0,1 Hz increments. When the utility frequency is more than the non-controllable generator over-frequency setpoint for longer than 4 seconds, the non-controllable generator shall cease to energise the utility line within 0,5 s.</p>		N/A
4.2.2.4	Prevention of islanding		P
4.2.2.4.1	A utility distribution network can become de-energized for several reasons: for example, a substation breaker that opens due to a fault condition or the distribution network might be switched off for maintenance purposes. Should the load and (embedded) generation within an isolated network be closely matched, then the voltage and frequency limits may not be triggered. If the embedded generator control system only made use of passive voltage and frequency out-of-bounds detection, this would result in an unintentional island that could continue beyond the allowed time limits.		P
4.2.2.4.2	In order to detect an islanding condition, the embedded generator shall make use of at least one active islanding detection method. An active islanding detection method intentionally varies an output parameter and monitors the response or it attempts to cause an abnormal condition at the utility interface to trigger an out-of-bounds condition. If the utility supply is available, the attempt to vary an output parameter or cause an abnormal condition will fail and no response will be detected. However, if the utility supply network is de-energized, there will be a response to the change which can be detected. This signals an island condition to the embedded generator upon detection of which the embedded generator shall cease to energize the utility network within a specific time period.		P
4.2.2.4.3	Active island detection shall be used in all cases where the EG interfaces with the utility network.		P
4.2.2.4.4	An islanding condition shall cause the embedded generator to cease to energize the utility network within 2 s, irrespective of connected loads or other embedded generators. The embedded generator employing active islanding detection shall comply with the requirements of IEC 62116 (ed. 1).		P

NRS 097-2-1:2017			
Clause	Requirement - Test	Result - Remark	Verdict
4.2.2.4.5	All rotating generators shall use a minimum of two islanding detection methods (e.g. rate-of-change-of-frequency and voltage vector shift detection due to the dead bands (slow detection) of islands in both methods).		P
4.2.2.4.6	Passive methods of islanding detection shall not be the sole method to detect an island condition. When used, passive methods of islanding detection shall be done by three-phase voltage detection and shall be verified by an AC voltage source.		P
4.2.2.4.7	The embedded generator shall physically disconnect from the utility network in accordance with the requirements in 4.2.2.2.		P
4.2.2.5	DC current injection		P
	The embedded generator shall not inject d.c. current greater than 0,5 % of the rated a.c. output current into the utility interface under any operating condition, measured over a 1-minute interval. The EG shall cease to energize the utility network within 500 ms if this threshold is exceeded.		P
4.2.3	Emergency personnel safety		N/A
	No requirements for emergency personnel safety (e.g. fire brigade) existed at the time of publication. It is expected that such issues will be dealt with in other documents, e.g. OHS Act, SANS 10142-1.		N/A
4.2.4	Response to utility recovery		P
4.2.4.1	The embedded generator shall ensure synchronisation before re-energizing at all times in accordance with 4.1.12.		P
4.2.4.2	After a voltage or frequency out-of-range condition that has caused the embedded generator to cease energizing the utility network, the generator shall not re-energize the utility network until the utility service voltage and frequency have remained within the specified ranges for a continuous and uninterrupted period of 60 s. The reconnection shall commence as follows:		P
4.2.4.2.1	Non-controllable generators may connect randomly within the 1 minute to 10 minute period after voltage and frequency recovery (period includes the 60 s to confirm recovery). The delay for non-controllable generators will each be set at a random value by the manufacturer, with the option of changing this to a utility provided setting. The random value shall be selected so that no more than 2 % of generators from any specific manufacturer will reconnect within 10s of each other.		N/A

NRS 097-2-1:2017			
Clause	Requirement - Test	Result - Remark	Verdict
4.2.4.2.2	Controllable generators may reconnect immediately after the 60 s delay confirming recovery of the system voltage and frequency at a maximum rate of 10 % of rated power per minute, i.e. full power output will only be reached after 10 minutes. This ramp rate may be modified at the request of the utility or in consultation with the utility.		P
4.2.5	Isolation		N/A
4.2.5.1	In line with SANS 10142-1 (as amended), each energy source should have its own, appropriately rated, isolation device.	Shall consider in the end installation	N/A
4.2.5.2	It is expected that isolation requirements will be dealt with in more detail in future in e.g. SANS 10142-1/3. Such requirements shall supersede 4.2.5.		N/A
4.2.5.3	The embedded generator shall provide a means of isolating from the utility interface in order to allow for safe maintenance of the EG. The disconnection device shall be a double pole for a single-phase EG, a three-pole for a three-phase delta-connected EG, and a four-pole for a three-phase star-connected EG. The grid supply side shall be wired as the source.		N/A
4.2.5.4	The breaking capacity of the isolation circuit-breaker closest to the point of utility connection shall be rated appropriately for the installation point in accordance with SANS 60947-2. This disconnection device does not need to be accessible to the utility.		N/A
4.2.5.5	For dedicated supplies, a means shall be provided of isolating from the point of supply in order to allow for safe maintenance of the utility network. The disconnection device shall be a double pole for a single-phase EG, a three-pole for a three-phase delta-connected EG, and a four-pole for a three-phase star-connected EG. This disconnection device shall be lockable and accessible to the utility.		N/A
4.2.6	Earthing		P
4.2.6.1	The electrical installation shall be earthed in accordance with SANS 10142-1 (as applicable). The earthing requirements for different embedded generation configurations in conjunction with the customer network are described in annex B for the most common earthing systems.	Shall consider in the end installation	N/A

NRS 097-2-1:2017			
Clause	Requirement - Test	Result - Remark	Verdict
	Installations with utility-interconnected inverters without simple separation shall make use of earth leakage protection which are able to respond to d.c. fault currents including smooth d.c. fault currents (i.e. without zero crossings) according to IEC 62109-2 unless the inverter can exclude the occurrence of d.c. earth fault currents on any phase, neutral or earth connection through its circuit design1). This function may be internal or external to the inverter.	integrated type B RCD according to IEC 62109-2	P
4.2.6.3	Where an electrical installation includes a PV power supply system without at least simple separation between the AC side and the DC side, an integrated RCD function shall be present to provide fault protection by automatic disconnection of supply shall be type B according to IEC/TR 60755, amendment 2. Where the PV inverter by construction is not able to feed DC fault currents into the electrical installation, an RCD of type B according to IEC/TR 60755 amendment 2 is not required.		P
4.2.7	Short-circuit protection		N/A
4.2.7.1	The embedded generator shall have suitably rated short-circuit protection at the connection to the AC mains in accordance with SANS 10142-1 and 3.	Shall consider in the end installation	N/A
4.2.7.2	The short-circuit characteristics for the SSEG shall be supplied to the utility.		N/A
4.2.8	Maximum short-circuit contribution		P
	Embedded generators have the potential to increase the fault level of the network to which it is connected. In order to limit the fault level changes in low voltage networks and allow coordination of fault levels with the utility, no generator will exceed the following fault level contribution: a) for synchronous generators: 8 times the rated current; b) for asynchronous generators: 6 times the rated current; and c) for generators with inverters: 1 times the rated current.		P
4.2.9	Labelling		P

NRS 097-2-1:2017			
Clause	Requirement - Test	Result - Remark	Verdict
4.2.9.1	A label on the distribution board of the premises where the embedded generator is connected shown in figure 6, shall state: "WARNING: ON-SITE EMBEDDED GENERATION. DO NOT WORK ON THIS EQUIPMENT UNTIL IT IS ISOLATED FROM BOTH MAINS AND ON-SITE GENERATION SUPPLIES." or similar warning. Disconnection points for all supplies shall be indicated.		P
4.2.9.2	The label shall be permanent with lettering of height at least 8 mm.		P
4.2.9.3	The label shall comply to requirements of SABS 1186-1.		P
4.2.9.4	The absence of emergency shutdown capabilities will be indicated on signage in accordance with 4.2.2.		N/A
4.2.10	Robustness requirements. According to 4.2.2.1 all SSEG shall comply with safety requirements in accordance to SANS/IEC 62109-1 and IEC 62109-2.		P

4.3	Metering		N/A
-----	-----------------	--	-----

Annex A	Notes to purchase	Info
Annex B	Earthing system	Info
Annex C	Network impedance	Nor
Annex D	(Annex A of VDE-AR-N 4105) Explanations	Nor
Annex E	(Annex B of VDE-AR-N 4105) Connection examples	Nor
Annex F	(Annex C of VDE-AR-N 4105) Example of meter panel configurations	Nor
Annex G	Generation management network security management	Nor

Appended Table - Testing Result

4.1.2	Table: Normal voltage operating range	P
4.1.9	Normal frequency operating range	

Normal operating at 0.85Vn 47Hz

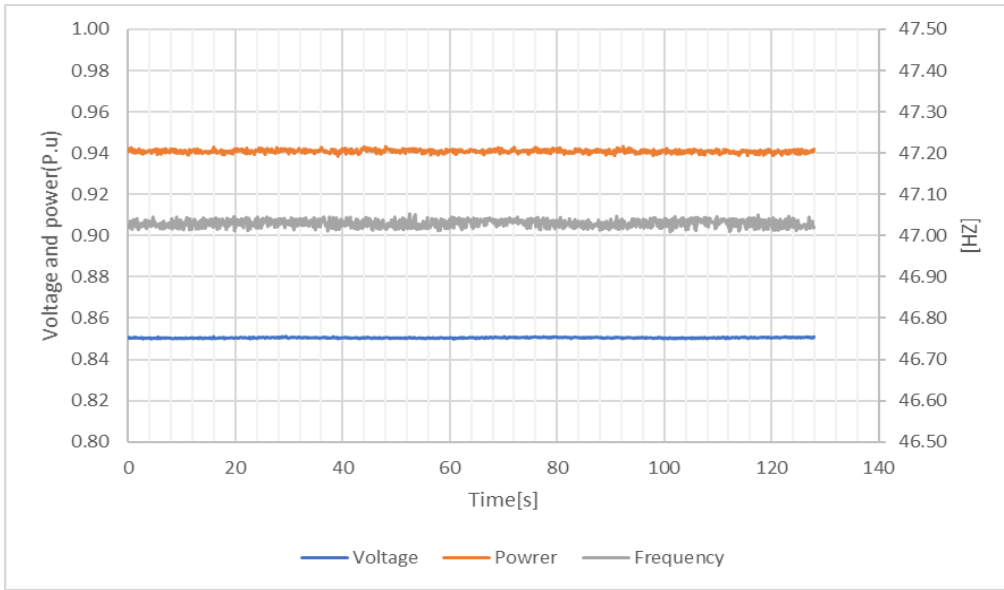

Normal operating at 1.1Vn 52Hz

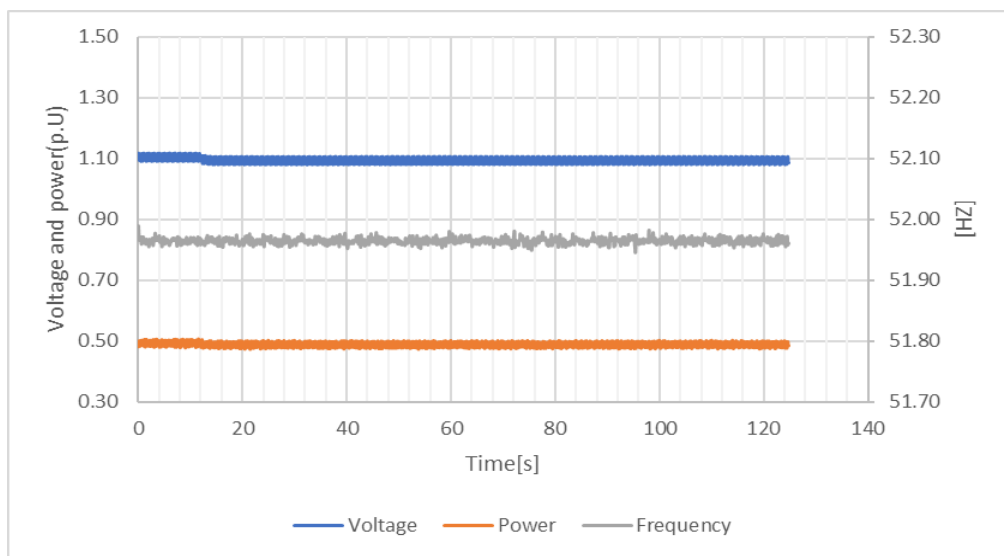

4.1.5.1		Table: Flicker test									P	
Model		LXP 5K Hybrid										
P _n (%)	10%	20%	30%	40%	50%	60%	70%	80%	90%	100%	Limit	
PST	0.08	0.08	0.08	0.09	0.09	0.10	0.10	0.11	0.11	0.12	≤ 0.35	
PLT	0.08	0.08	0.08	0.08	0.09	0.09	0.10	0.10	0.11	0.11	≤ 0.30	

Note:
Network strength: Z_{source} = 1.05 + j 0.32 ohm

5K					
10%Power					
Flicker Mode Uover:■■■■ U2 : 300V YOKOGAWA ◆ Iover:■■■■ Flicker:Complete 2:00:00					
Count ██████████ 12/12 Interval ██████████ 10m00s/10m00s Element 2 Volt Range A 300V/50Hz Element2 Judgement: Pass Un (U2) 198.102 V Total Judgement: Pass Freq(U2) 47.500 Hz (Element2)					
	dc[%]	dmax[%]	d(t)[ms]	Pst	PIt
Limit	3.30	4.00	500 3.30(%)	1.00	0.65 N:12
No. 1	0.08 Pass	0.23 Pass	0 Pass	0.08 Pass	
2	0.04 Pass	0.17 Pass	0 Pass	0.08 Pass	
3	0.07 Pass	0.27 Pass	0 Pass	0.08 Pass	
4	0.08 Pass	0.18 Pass	0 Pass	0.08 Pass	
5	0.06 Pass	0.15 Pass	0 Pass	0.08 Pass	
6	0.06 Pass	0.11 Pass	0 Pass	0.08 Pass	
7	0.06 Pass	0.20 Pass	0 Pass	0.08 Pass	
8	0.07 Pass	0.19 Pass	0 Pass	0.08 Pass	
9	0.08 Pass	0.25 Pass	0 Pass	0.08 Pass	
10	0.08 Pass	0.14 Pass	0 Pass	0.08 Pass	
11	0.07 Pass	0.13 Pass	0 Pass	0.08 Pass	
12	0.06 Pass	0.12 Pass	0 Pass	0.08 Pass	
Result	Pass	Pass	Pass	Pass	0.08 Pass

Update 3600 2019/07/05 17:08:02

20%Power					
Flicker Mode Uover:■■■■ U2 : 300V YOKOGAWA ◆ Iover:■■■■ Flicker:Complete 2:00:00					
Count ██████████ 12/12 Interval ██████████ 10m00s/10m00s Element 2 Volt Range A 300V/50Hz Element2 Judgement: Pass Un (U2) 198.205 V Total Judgement: Pass Freq(U2) 47.501 Hz (Element2)					
	dc[%]	dmax[%]	d(t)[ms]	Pst	PIt
Limit	3.30	4.00	500 3.30(%)	1.00	0.65 N:12
No. 1	0.05 Pass	0.11 Pass	0 Pass	0.08 Pass	
2	0.17 Pass	0.17 Pass	0 Pass	0.08 Pass	
3	0.16 Pass	0.21 Pass	0 Pass	0.08 Pass	
4	0.11 Pass	0.17 Pass	0 Pass	0.08 Pass	
5	0.19 Pass	0.19 Pass	0 Pass	0.08 Pass	
6	0.09 Pass	0.21 Pass	0 Pass	0.08 Pass	
7	0.09 Pass	0.17 Pass	0 Pass	0.08 Pass	
8	0.09 Pass	0.18 Pass	0 Pass	0.08 Pass	
9	0.08 Pass	0.19 Pass	0 Pass	0.08 Pass	
10	0.09 Pass	0.19 Pass	0 Pass	0.08 Pass	
11	0.07 Pass	0.14 Pass	0 Pass	0.08 Pass	
12	0.18 Pass	0.21 Pass	0 Pass	0.08 Pass	
Result	Pass	Pass	Pass	Pass	0.08 Pass

Update 3600 2019/07/05 15:04:18

30%Power					
Flicker Mode		Uover: ■ ■ ■ ■ Iover: ■ ■ ■ ■		YOKOGAWA ◆ Flicker:Complete 2:00:00	
Count		12/12			
Interval		10m00s/10m00s			
Element 2					
Volt Range A 300V/50Hz		Element2 Judgement: Pass			
Un (U2) 230.339 V		Total Judgement: Pass			
Freq(U2) 50.002 Hz		(Element2)			
Limit	dc[%]	dmax[%]	d(t)[ms]	Pst	P1t
	3.30	4.00	500 3.30(%)	1.00	0.65 N:12
No. 1	0.04 Pass	0.14 Pass	0 Pass	0.07 Pass	
2	0.11 Pass	0.21 Pass	0 Pass	0.08 Pass	
3	0.17 Pass	0.22 Pass	0 Pass	0.08 Pass	
4	0.16 Pass	0.21 Pass	0 Pass	0.08 Pass	
5	0.07 Pass	0.10 Pass	0 Pass	0.07 Pass	
6	0.15 Pass	0.22 Pass	0 Pass	0.08 Pass	
7	0.14 Pass	0.24 Pass	0 Pass	0.08 Pass	
8	0.11 Pass	0.21 Pass	0 Pass	0.08 Pass	
9	0.13 Pass	0.21 Pass	0 Pass	0.08 Pass	
10	0.09 Pass	0.19 Pass	0 Pass	0.08 Pass	
11	0.15 Pass	0.23 Pass	0 Pass	0.08 Pass	
12	0.16 Pass	0.22 Pass	0 Pass	0.08 Pass	
Result	Pass	Pass	Pass	Pass	0.08 Pass
Update 3600		2019/07/05 11:39:19			

40%Power					
Flicker Mode		Uover: ■ ■ ■ ■ Iover: ■ ■ ■ ■		YOKOGAWA ◆ Flicker:Complete 2:00:00	
Count		12/12			
Interval		10m00s/10m00s			
Element 2					
Volt Range A 300V/50Hz		Element2 Judgement: Pass			
Un (U2) 230.061 V		Total Judgement: Pass			
Freq(U2) 50.000 Hz		(Element2)			
Limit	dc[%]	dmax[%]	d(t)[ms]	Pst	P1t
	3.30	4.00	500 3.30(%)	1.00	0.65 N:12
No. 1	0.00 Pass	0.00 Pass	0 Pass	0.07 Pass	
2	0.21 Pass	0.30 Pass	0 Pass	0.09 Pass	
3	0.08 Pass	0.11 Pass	0 Pass	0.07 Pass	
4	0.16 Pass	0.26 Pass	0 Pass	0.08 Pass	
5	0.19 Pass	0.28 Pass	0 Pass	0.08 Pass	
6	0.18 Pass	0.29 Pass	0 Pass	0.08 Pass	
7	0.15 Pass	0.23 Pass	0 Pass	0.08 Pass	
8	0.04 Pass	0.25 Pass	0 Pass	0.07 Pass	
9	0.18 Pass	0.27 Pass	0 Pass	0.08 Pass	
10	0.22 Pass	0.27 Pass	0 Pass	0.08 Pass	
11	0.14 Pass	0.30 Pass	0 Pass	0.08 Pass	
12	0.17 Pass	0.26 Pass	0 Pass	0.08 Pass	
Result	Pass	Pass	Pass	Pass	0.08 Pass
Update 3600		2019/07/04 17:18:25			

50%Power					
Flicker Mode		Uover: ■ ■ ■ ■	U1 : 600V	YOKOGAWA ◆	
		Iover: ■ ■ ■ ■	Flicker: Complete 2:00:00		
Count	████████████████████				12/12
Interval	████████████████████				10m00s/10m00s
Element	2				
Volt Range A	300V/50Hz		Element2 Judgement:	Pass	
Un (U2)	230.564 V		Total Judgement:	Pass	
Freq(U2)	50.001 Hz		(Element2)		
Limit	dc[%]	dmax[%]	d(t)[ms]	Pst	P1t
	3.30	4.00	500 3.30(%)	1.00	0.65 N: 12
No. 1	0.18 Pass	0.33 Pass	0 Pass	0.08 Pass	
2	0.10 Pass	0.33 Pass	0 Pass	0.09 Pass	
3	0.26 Pass	0.35 Pass	0 Pass	0.09 Pass	
4	0.18 Pass	0.34 Pass	0 Pass	0.09 Pass	
5	0.14 Pass	0.34 Pass	0 Pass	0.09 Pass	
6	0.18 Pass	0.34 Pass	0 Pass	0.09 Pass	
7	0.15 Pass	0.31 Pass	0 Pass	0.09 Pass	
8	0.14 Pass	0.32 Pass	0 Pass	0.09 Pass	
9	0.21 Pass	0.38 Pass	0 Pass	0.09 Pass	
10	0.20 Pass	0.37 Pass	0 Pass	0.09 Pass	
11	0.16 Pass	0.33 Pass	0 Pass	0.09 Pass	
12	0.21 Pass	0.32 Pass	0 Pass	0.08 Pass	
Result	Pass	Pass	Pass	Pass	0.09 Pass
Update 3600		2019/07/04 12:22:21			

60%Power					
Flicker Mode		Uover: ■ ■ ■ ■	U1 : 100V	YOKOGAWA ◆	
		Iover: ■ ■ ■ ■	Flicker: Complete 2:00:00		
Count	████████████████████				12/12
Interval	████████████████████				10m00s/10m00s
Element	2				
Volt Range A	300V/50Hz		Element2 Judgement:	Pass	
Un (U2)	230.265 V		Total Judgement:	Pass	
Freq(U2)	50.001 Hz		(Element2)		
Limit	dc[%]	dmax[%]	d(t)[ms]	Pst	P1t
	3.30	4.00	500 3.30(%)	1.00	0.65 N: 12
No. 1	0.00 Pass	0.00 Pass	0 Pass	0.07 Pass	
2	0.16 Pass	0.42 Pass	0 Pass	0.10 Pass	
3	0.25 Pass	0.42 Pass	0 Pass	0.09 Pass	
4	0.27 Pass	0.40 Pass	0 Pass	0.09 Pass	
5	0.21 Pass	0.38 Pass	0 Pass	0.09 Pass	
6	0.20 Pass	0.39 Pass	0 Pass	0.09 Pass	
7	0.22 Pass	0.37 Pass	0 Pass	0.09 Pass	
8	0.20 Pass	0.42 Pass	0 Pass	0.10 Pass	
9	0.19 Pass	0.40 Pass	0 Pass	0.09 Pass	
10	0.21 Pass	0.44 Pass	0 Pass	0.09 Pass	
11	0.19 Pass	0.39 Pass	0 Pass	0.09 Pass	
12	0.19 Pass	0.41 Pass	0 Pass	0.09 Pass	
Result	Pass	Pass	Pass	Pass	0.09 Pass
Update 3600		2019/07/03 17:10:48			

70%Power					
Flicker Mode		Uover: ■ ■ ■ ■	I2 :500mA	YOKOGAWA ◆	
		Iover: ■ ■ ■ ■	Flicker:Complete 2:00:00		
Count	████████████████████				12/12
Interval	████████████████████				10m00s/10m00s
Element	2				
Volt Range A	300V/50Hz		Element2 Judgement:	Pass	
Un (U2)	230.402 V		Total Judgement:	Pass	
Freq(U2)	50.001 Hz		(Element2)		
Limit	dc[%]	dmax[%]	d(t)[ms]	Pst	P1t
	3.30	4.00	500 3.30(%)	1.00	0.65 N:12
No. 1	0.05 Pass	0.11 Pass	0 Pass	0.07 Pass	
2	0.24 Pass	0.50 Pass	0 Pass	0.09 Pass	
3	0.32 Pass	0.48 Pass	0 Pass	0.10 Pass	
4	0.21 Pass	0.47 Pass	0 Pass	0.10 Pass	
5	0.25 Pass	0.47 Pass	0 Pass	0.10 Pass	
6	0.38 Pass	0.47 Pass	0 Pass	0.09 Pass	
7	0.24 Pass	0.48 Pass	0 Pass	0.10 Pass	
8	0.23 Pass	0.45 Pass	0 Pass	0.10 Pass	
9	0.37 Pass	0.47 Pass	0 Pass	0.09 Pass	
10	0.20 Pass	0.48 Pass	0 Pass	0.09 Pass	
11	0.28 Pass	0.49 Pass	0 Pass	0.10 Pass	
12	0.24 Pass	0.46 Pass	0 Pass	0.09 Pass	
Result	Pass	Pass	Pass	Pass	0.10 Pass
Update 3600			2019/07/03 14:34:52		

80%Power					
Flicker Mode		Uover: ■ ■ ■ ■	I2 :500mA	YOKOGAWA ◆	
		Iover: ■ ■ ■ ■	Flicker:Complete 2:00:00		
Count	████████████████████				12/12
Interval	████████████████████				10m00s/10m00s
Element	2				
Volt Range A	300V/50Hz		Element2 Judgement:	Pass	
Un (U2)	230.456 V		Total Judgement:	Pass	
Freq(U2)	50.001 Hz		(Element2)		
Limit	dc[%]	dmax[%]	d(t)[ms]	Pst	P1t
	3.30	4.00	500 3.30(%)	1.00	0.65 N:12
No. 1	0.02 Pass	0.22 Pass	0 Pass	0.07 Pass	
2	0.29 Pass	0.54 Pass	0 Pass	0.10 Pass	
3	0.32 Pass	0.55 Pass	0 Pass	0.10 Pass	
4	0.24 Pass	0.50 Pass	0 Pass	0.11 Pass	
5	0.25 Pass	0.49 Pass	0 Pass	0.10 Pass	
6	0.29 Pass	0.51 Pass	0 Pass	0.11 Pass	
7	0.29 Pass	0.54 Pass	0 Pass	0.10 Pass	
8	0.25 Pass	0.54 Pass	0 Pass	0.10 Pass	
9	0.33 Pass	0.49 Pass	0 Pass	0.11 Pass	
10	0.25 Pass	0.53 Pass	0 Pass	0.10 Pass	
11	0.29 Pass	0.52 Pass	0 Pass	0.10 Pass	
12	0.28 Pass	0.53 Pass	0 Pass	0.10 Pass	
Result	Pass	Pass	Pass	Pass	0.10 Pass
Update 3600			2019/07/03 12:22:57		

Mode	LXP 3K Hybrid										
P_n(%)	10%	20%	30%	40%	50%	60%	70%	80%	90%	100%	Limit
PST	0.07	0.08	0.08	0.08	0.08	0.08	0.10	0.09	0.09	0.10	≤ 0.35
PLT	0.07	0.07	0.08	0.08	0.08	0.08	0.09	0.09	0.09	0.09	≤ 0.30

Note:
Network strength: Z_{source} = 1.05 + j 0.32 ohm

10%Power					
Flicker Mode		Uover: ■ ■ ■ ■	U2 : 300V	YOKOGAWA ◆	
		Iover: ■ ■ ■ ■	Flicker:Complete 2:00:00		
Count	████████████████████				12/12
Interval	████████████████████				10m00s/10m00s
Element	2				
Volt Range	300V/50Hz				Element2 Judgement: Pass
Un (U2)	230.107 V				Total Judgement: Pass
Freq(U2)	49.999 Hz				(Element2)
	dc[%]	dmax[%]	d(t)[ms]	Pst	P1t
Limit	3.30	4.00	500	1.00	0.65
	3.30(%)				N: 12
No. 1	0.06 Pass	0.18 Pass	0 Pass	0.07 Pass	
2	0.00 Pass	0.00 Pass	0 Pass	0.07 Pass	
3	0.04 Pass	0.11 Pass	0 Pass	0.07 Pass	
4	0.05 Pass	0.10 Pass	0 Pass	0.07 Pass	
5	0.04 Pass	0.13 Pass	0 Pass	0.07 Pass	
6	0.08 Pass	0.13 Pass	0 Pass	0.07 Pass	
7	0.05 Pass	0.15 Pass	0 Pass	0.07 Pass	
8	0.07 Pass	0.18 Pass	0 Pass	0.07 Pass	
9	0.01 Pass	0.10 Pass	0 Pass	0.07 Pass	
10	0.06 Pass	0.10 Pass	0 Pass	0.07 Pass	
11	0.05 Pass	0.11 Pass	0 Pass	0.07 Pass	
12	0.10 Pass	0.13 Pass	0 Pass	0.07 Pass	
Result	Pass	Pass	Pass	Pass	0.07 Pass
Update 3600		2019/07/06 11:17:40			

20%Power					
Flicker Mode		Uover: ■ ■ ■ ■	U2 : 300V	YOKOGAWA ◆	
		Iover: ■ ■ ■ ■	Flicker:Complete 2:00:00		
Count	████████████████████				12/12
Interval	████████████████████				10m00s/10m00s
Element	2				
Volt Range	300V/50Hz				Element2 Judgement: Pass
Un (U2)	230.241 V				Total Judgement: Pass
Freq(U2)	50.001 Hz				(Element2)
	dc[%]	dmax[%]	d(t)[ms]	Pst	P1t
Limit	3.30	4.00	500	1.00	0.65
	3.30(%)				N: 12
No. 1	0.09 Pass	0.12 Pass	0 Pass	0.07 Pass	
2	0.09 Pass	0.12 Pass	0 Pass	0.08 Pass	
3	0.08 Pass	0.10 Pass	0 Pass	0.07 Pass	
4	0.09 Pass	0.14 Pass	0 Pass	0.08 Pass	
5	0.11 Pass	0.15 Pass	0 Pass	0.07 Pass	
6	0.06 Pass	0.15 Pass	0 Pass	0.07 Pass	
7	0.08 Pass	0.11 Pass	0 Pass	0.07 Pass	
8	0.09 Pass	0.13 Pass	0 Pass	0.07 Pass	
9	0.05 Pass	0.10 Pass	0 Pass	0.07 Pass	
10	0.08 Pass	0.11 Pass	0 Pass	0.07 Pass	
11	0.09 Pass	0.20 Pass	0 Pass	0.07 Pass	
12	0.07 Pass	0.10 Pass	0 Pass	0.07 Pass	
Result	Pass	Pass	Pass	Pass	0.07 Pass
Update 3600		2019/07/06 13:21:03			

30%Power					
Flicker Mode		Uover: ■■■■	U2 : 300V	YOKOGAWA ◆	
		Iover: ■■■■	Flicker:Complete 2:00:00		
Count		■■■■■■■■■■■■■■■■ 12/12			
Interval		■■■■■■■■■■■■■■■■ 10m00s/10m00s			
Element 2					
Volt Range 300V/50Hz		Element2 Judgement: Pass			
Un (U2) 230.247 V		Total Judgement: Pass			
Freq(U2) 50.000 Hz		(Element2)			
Limit	dc[%]	dmax[%]	d(t)[ms]	Pst	P1t
	3.30	4.00	500 3.30(%)	1.00	0.65 N: 12
No. 1	0.06 Pass	0.10 Pass	0 Pass	0.07 Pass	
2	0.09 Pass	0.15 Pass	0 Pass	0.08 Pass	
3	0.09 Pass	0.17 Pass	0 Pass	0.08 Pass	
4	0.14 Pass	0.21 Pass	0 Pass	0.08 Pass	
5	0.11 Pass	0.15 Pass	0 Pass	0.08 Pass	
6	0.12 Pass	0.18 Pass	0 Pass	0.08 Pass	
7	0.18 Pass	0.19 Pass	0 Pass	0.08 Pass	
8	0.15 Pass	0.15 Pass	0 Pass	0.07 Pass	
9	0.10 Pass	0.13 Pass	0 Pass	0.08 Pass	
10	0.10 Pass	0.14 Pass	0 Pass	0.08 Pass	
11	0.07 Pass	0.12 Pass	0 Pass	0.08 Pass	
12	0.12 Pass	0.18 Pass	0 Pass	0.08 Pass	
Result	Pass	Pass	Pass	Pass	0.08 Pass
Update 3600			2019/07/06 15:22:49		

40%Power					
Flicker Mode		Uover: ■■■■	U2 : 300V	YOKOGAWA ◆	
		Iover: ■■■■	Flicker:Complete 2:00:00		
Count		■■■■■■■■■■■■■■■■ 12/12			
Interval		■■■■■■■■■■■■■■■■ 10m00s/10m00s			
Element 2					
Volt Range 300V/50Hz		Element2 Judgement: Pass			
Un (U2) 230.177 V		Total Judgement: Pass			
Freq(U2) 50.000 Hz		(Element2)			
Limit	dc[%]	dmax[%]	d(t)[ms]	Pst	P1t
	3.30	4.00	500 3.30(%)	1.00	0.65 N: 12
No. 1	0.05 Pass	0.11 Pass	0 Pass	0.07 Pass	
2	0.13 Pass	0.20 Pass	0 Pass	0.08 Pass	
3	0.18 Pass	0.26 Pass	0 Pass	0.08 Pass	
4	0.09 Pass	0.19 Pass	0 Pass	0.08 Pass	
5	0.16 Pass	0.21 Pass	0 Pass	0.08 Pass	
6	0.13 Pass	0.22 Pass	0 Pass	0.08 Pass	
7	0.12 Pass	0.21 Pass	0 Pass	0.08 Pass	
8	0.12 Pass	0.20 Pass	0 Pass	0.08 Pass	
9	0.14 Pass	0.21 Pass	0 Pass	0.08 Pass	
10	0.12 Pass	0.18 Pass	0 Pass	0.08 Pass	
11	0.10 Pass	0.18 Pass	0 Pass	0.08 Pass	
12	0.14 Pass	0.25 Pass	0 Pass	0.08 Pass	
Result	Pass	Pass	Pass	Pass	0.08 Pass
Update 3600			2019/07/06 17:26:25		

50%Power					
Flicker Mode	Uover: ■ ■ ■ ■	U2 : 300V	YOKOGAWA ◆		
	Iover: ■ ■ ■ ■	Flicker:Complete 2:00:00			
Count	████████████████████ 12/12				
Interval	████████████████████ 10m00s/10m00s				
Element	2				
Volt Range	300V/50Hz		Element2 Judgement: Pass		
Un (U2)	230.319 V		Total Judgement: Pass		
Freq(U2)	50.001 Hz		(Element2)		
	dc[%]	dmax[%]	d(t)[ms]	Pst	P1t
Limit	3.30	4.00	500 3.30(%)	1.00	0.65 N:12
No. 1	0.07 Pass	0.23 Pass	0 Pass	0.08 Pass	
2	0.18 Pass	0.27 Pass	0 Pass	0.08 Pass	
3	0.14 Pass	0.28 Pass	0 Pass	0.08 Pass	
4	0.19 Pass	0.27 Pass	0 Pass	0.08 Pass	
5	0.21 Pass	0.27 Pass	0 Pass	0.08 Pass	
6	0.19 Pass	0.27 Pass	0 Pass	0.08 Pass	
7	0.17 Pass	0.25 Pass	0 Pass	0.08 Pass	
8	0.19 Pass	0.29 Pass	0 Pass	0.08 Pass	
9	0.17 Pass	0.30 Pass	0 Pass	0.08 Pass	
10	0.14 Pass	0.28 Pass	0 Pass	0.08 Pass	
11	0.15 Pass	0.29 Pass	0 Pass	0.08 Pass	
12	0.10 Pass	0.25 Pass	0 Pass	0.08 Pass	
Result	Pass	Pass	Pass	Pass	0.08 Pass
Update 3600		2019/07/08 11:22:55			

60%Power					
Flicker Mode	Uover: ■ ■ ■ ■	U2 : 300V	YOKOGAWA ◆		
	Iover: ■ ■ ■ ■	Flicker:Complete 2:00:00			
Count	████████████████████ 12/12				
Interval	████████████████████ 10m00s/10m00s				
Element	2				
Volt Range	300V/50Hz		Element2 Judgement: Pass		
Un (U2)	230.311 V		Total Judgement: Pass		
Freq(U2)	50.000 Hz		(Element2)		
	dc[%]	dmax[%]	d(t)[ms]	Pst	P1t
Limit	3.30	4.00	500 3.30(%)	1.00	0.65 N:12
No. 1	0.00 Pass	0.00 Pass	0 Pass	0.07 Pass	
2	0.18 Pass	0.30 Pass	0 Pass	0.08 Pass	
3	0.20 Pass	0.28 Pass	0 Pass	0.08 Pass	
4	0.20 Pass	0.29 Pass	0 Pass	0.08 Pass	
5	0.17 Pass	0.28 Pass	0 Pass	0.08 Pass	
6	0.18 Pass	0.31 Pass	0 Pass	0.08 Pass	
7	0.18 Pass	0.32 Pass	0 Pass	0.08 Pass	
8	0.16 Pass	0.27 Pass	0 Pass	0.08 Pass	
9	0.18 Pass	0.27 Pass	0 Pass	0.08 Pass	
10	0.21 Pass	0.30 Pass	0 Pass	0.08 Pass	
11	0.18 Pass	0.27 Pass	0 Pass	0.08 Pass	
12	0.19 Pass	0.26 Pass	0 Pass	0.08 Pass	
Result	Pass	Pass	Pass	Pass	0.08 Pass
Update 3600		2019/07/08 13:26:02			



70%Power					
Flicker Mode		Uover: ■ ■ ■ ■	U2 : 300V	YOKOGAWA ◆	
		Iover: ■ ■ ■ ■	Flicker:Complete 2:00:00		
Count		12/12			
Interval		10m00s/10m00s			
Element	2				
Volt Range	300V/50Hz		Element2 Judgement: Pass		
Un (U2)	230.247 V		Total Judgement: Pass		
Freq(U2)	50.001 Hz		(Element2)		
	dc[%]	dmax[%]	d(t)[ms]	Pst	P1t
Limit	3.30	4.00	500 3.30(%)	1.00	0.65 N:12
No. 1	0.00 Pass	0.00 Pass	0 Pass	0.07 Pass	
2	0.19 Pass	0.32 Pass	0 Pass	0.09 Pass	
3	0.14 Pass	0.24 Pass	0 Pass	0.08 Pass	
4	0.17 Pass	0.33 Pass	0 Pass	0.09 Pass	
5	0.18 Pass	0.28 Pass	0 Pass	0.08 Pass	
6	0.22 Pass	0.31 Pass	0 Pass	0.08 Pass	
7	0.18 Pass	0.34 Pass	0 Pass	0.09 Pass	
8	0.27 Pass	0.33 Pass	0 Pass	0.08 Pass	
9	0.22 Pass	0.33 Pass	0 Pass	0.10 Pass	
10	0.09 Pass	0.12 Pass	0 Pass	0.07 Pass	
11	0.19 Pass	0.36 Pass	0 Pass	0.09 Pass	
12	0.17 Pass	0.34 Pass	0 Pass	0.08 Pass	
Result	Pass	Pass	Pass	Pass	0.09 Pass
Update 3600		2019/07/08 15:27:38			

80%Power					
Flicker Mode		Uover: ■ ■ ■ ■	I2 : 500mA	YOKOGAWA ◆	
		Iover: ■ ■ ■ ■	Flicker:Complete 2:00:00		
Count		12/12			
Interval		10m00s/10m00s			
Element	2				
Volt Range	300V/50Hz		Element2 Judgement: Pass		
Un (U2)	230.269 V		Total Judgement: Pass		
Freq(U2)	50.000 Hz		(Element2)		
	dc[%]	dmax[%]	d(t)[ms]	Pst	P1t
Limit	3.30	4.00	500 3.30(%)	1.00	0.65 N:12
No. 1	0.10 Pass	0.16 Pass	0 Pass	0.07 Pass	
2	0.14 Pass	0.33 Pass	0 Pass	0.09 Pass	
3	0.25 Pass	0.35 Pass	0 Pass	0.09 Pass	
4	0.14 Pass	0.34 Pass	0 Pass	0.09 Pass	
5	0.19 Pass	0.34 Pass	0 Pass	0.09 Pass	
6	0.16 Pass	0.30 Pass	0 Pass	0.09 Pass	
7	0.17 Pass	0.33 Pass	0 Pass	0.09 Pass	
8	0.22 Pass	0.36 Pass	0 Pass	0.09 Pass	
9	0.18 Pass	0.36 Pass	0 Pass	0.09 Pass	
10	0.15 Pass	0.38 Pass	0 Pass	0.09 Pass	
11	0.16 Pass	0.32 Pass	0 Pass	0.09 Pass	
12	0.16 Pass	0.36 Pass	0 Pass	0.09 Pass	
Result	Pass	Pass	Pass	Pass	0.09 Pass
Update 3600		2019/07/08 19:26:12			

90%Power					
Flicker Mode		Uover: ■ ■ ■ ■ Iover: ■ ■ ■ ■		YOKOGAWA ◆	
				Flicker:Complete 2:00:00	
		Count ██████████ 12/12			
		Interval ██████████ 10m00s/10m00s			
Element 2					
Volt Range 300V/50Hz		Element2 Judgement: Pass			
Un (U2) 230.347 V		Total Judgement: Pass			
Freq(U2) 50.001 Hz		(Element2)			
	dc[%]	dmax[%]	d(t)[ms]	Pst	P1t
Limit	3.30	4.00	500 3.30(%)	1.00	0.65 N:12
No. 1	0.04 Pass	0.10 Pass	0 Pass	0.07 Pass	
2	0.29 Pass	0.47 Pass	0 Pass	0.09 Pass	
3	0.22 Pass	0.42 Pass	0 Pass	0.09 Pass	
4	0.19 Pass	0.39 Pass	0 Pass	0.09 Pass	
5	0.26 Pass	0.44 Pass	0 Pass	0.09 Pass	
6	0.17 Pass	0.38 Pass	0 Pass	0.09 Pass	
7	0.25 Pass	0.39 Pass	0 Pass	0.09 Pass	
8	0.27 Pass	0.42 Pass	0 Pass	0.09 Pass	
9	0.27 Pass	0.42 Pass	0 Pass	0.09 Pass	
10	0.22 Pass	0.41 Pass	0 Pass	0.09 Pass	
11	0.24 Pass	0.38 Pass	0 Pass	0.09 Pass	
12	0.22 Pass	0.37 Pass	0 Pass	0.09 Pass	
Result	Pass	Pass	Pass	Pass	0.09 Pass
Update 3600		2019/07/09 11:20:12			

100%Power					
Flicker Mode		Uover: ■ ■ ■ ■ Iover: ■ ■ ■ ■		YOKOGAWA ◆	
				Flicker:Complete 2:00:00	
		Count ██████████ 12/12			
		Interval ██████████ 10m00s/10m00s			
Element 2					
Volt Range 300V/50Hz		Element2 Judgement: Pass			
Un (U2) 230.273 V		Total Judgement: Pass			
Freq(U2) 50.000 Hz		(Element2)			
	dc[%]	dmax[%]	d(t)[ms]	Pst	P1t
Limit	3.30	4.00	500 3.30(%)	1.00	0.65 N:12
No. 1	0.07 Pass	0.11 Pass	0 Pass	0.07 Pass	
2	0.23 Pass	0.43 Pass	0 Pass	0.09 Pass	
3	0.23 Pass	0.43 Pass	0 Pass	0.09 Pass	
4	0.17 Pass	0.43 Pass	0 Pass	0.10 Pass	
5	0.21 Pass	0.45 Pass	0 Pass	0.10 Pass	
6	0.24 Pass	0.43 Pass	0 Pass	0.10 Pass	
7	0.20 Pass	0.42 Pass	0 Pass	0.09 Pass	
8	0.22 Pass	0.43 Pass	0 Pass	0.10 Pass	
9	0.20 Pass	0.41 Pass	0 Pass	0.10 Pass	
10	0.24 Pass	0.48 Pass	0 Pass	0.10 Pass	
11	0.24 Pass	0.41 Pass	0 Pass	0.10 Pass	
12	0.31 Pass	0.41 Pass	0 Pass	0.09 Pass	
Result	Pass	Pass	Pass	Pass	0.09 Pass
Update 3600		2019/07/09 13:29:07			

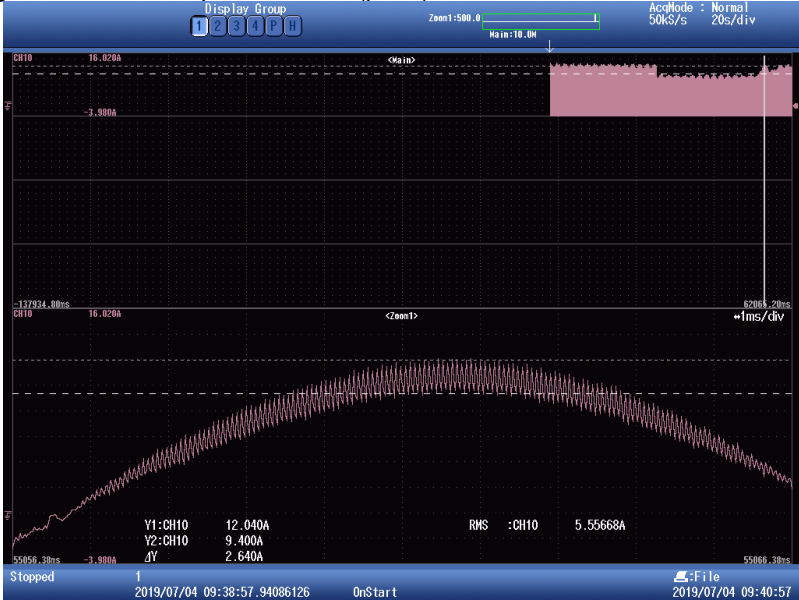
4.1.5.3	Table: voltage change			P
Test method: VDE 0124-100 par. 5.1 System perturbations VDE 0124-100 par. 5.1.2 Rapid voltage changes				
Operation type: start-up at 10%Pn with circuit breaker reclosing				
Condition	Test 1: $\cos\phi=1$	Test 2: $\cos\phi=0.95_{\text{over-excited}}$	Test 1: $\cos\phi=0.95_{\text{under-excited}}$	
Ki	0.70	0.79	0.64	
Kimax Limit	<1			
Operation type: start-up at Pn (reference condition) with circuit breaker reclosing				
Condition	Test 1: $\cos\phi=1$	Test 2: $\cos\phi=0.9_{\text{over-excited}}$	Test 1: $\cos\phi=0.9_{\text{under-excited}}$	
Ki	0.38	0.84	0.76	
Kimax Limit	<1			
Operation type: shut-down (breaking operation at nominal power)				
Condition	Test 1: $\cos\phi=1$	Test 2: $\cos\phi=0.9_{\text{over-excited}}$	Test 1: $\cos\phi=0.9_{\text{under-excited}}$	
Ki	0.31	0.87	0.49	
Kimax Limit	<1			
Note:				
1) $S_{k, fic}/S_n = 20$				
2) ki is the ratio of the highest current occurring during a switching operation to the normal generator current, the current is to be considered as an r.m.s. value over a period				

4.1.7	Table: Commutation notches	P
Test method:		
<p>VDE 0124-100 par. 5.1 System perturbations VDE 0124-100 par. 5.1.5 Commutation notches</p>		
<p style="text-align: center;">Test A –From 25%PEmax to 35% PEmax</p> <p>Sampling of switching current on wave peak: 2.640A (peak)</p>  <p style="text-align: center;">Test B –From 65%PEmax to 75% PEmax</p> <p>Sampling of switching current on wave peak: 3.150A (peak)</p> 		

Test C - >90% P_Emax

Sampling of switching current on wave peak: 4.000 A (peak)



4.1.8	Table: DC injection					P
The embedded generator shall not inject d.c. current greater than 0.5 % of the rated a.c. output current into the utility interface under any operating condition, measured over a 1-minute interval. The EG shall cease to energize the utility network within 500 ms if this threshold is exceeded.						
Model: LXP 3K Hybrid						
Pn[%]	10%Pn	20%Pn	30%Pn	40%Pn	50%Pn	Limited
d.c. current measured result (mA) (max. value)	19.2	17.8	23.0	16.6	6.3	65.0
Pn[%]	60%Pn	70%Pn	80%Pn	90%Pn	100%Pn	Limited
d.c. current measured result (mA) (max. value)	26.9	28.5	55.8	24.0	39.3	65.0

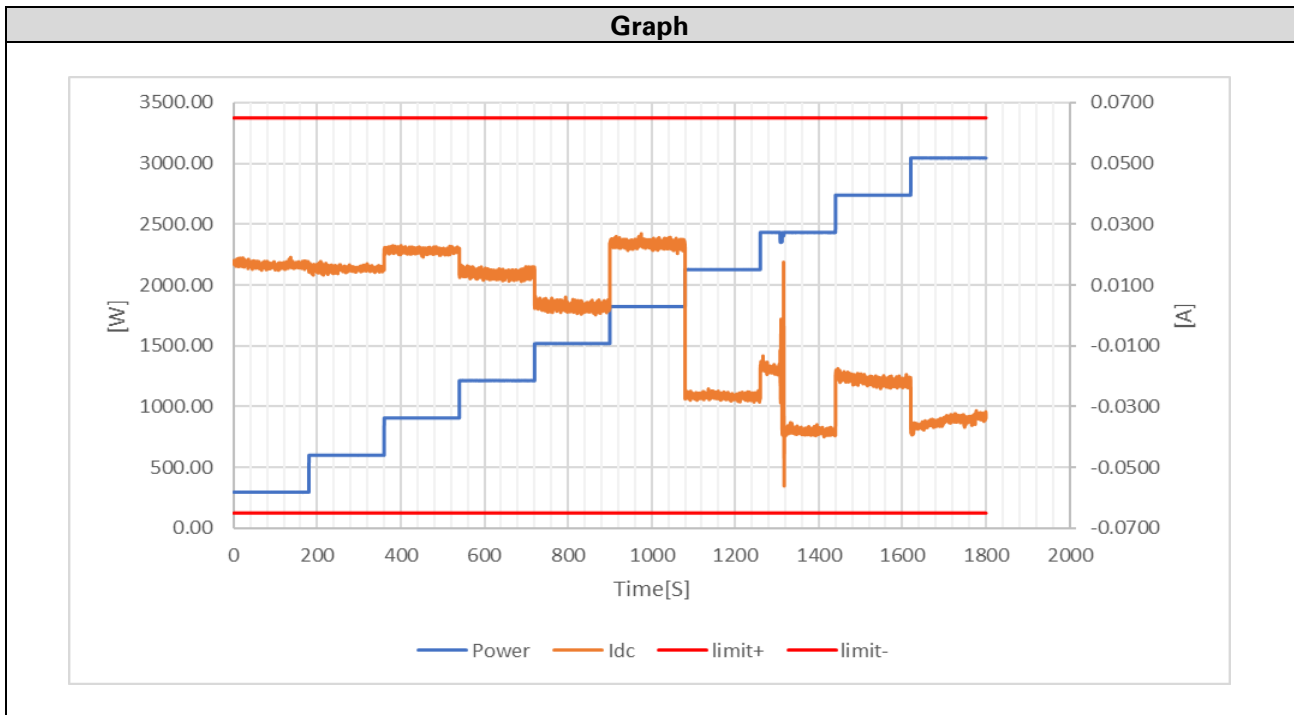

Model: LXP 5K Hybrid						
Pn[%]	10%Pn	20%Pn	30%Pn	40%Pn	50%Pn	Limited
d.c. current measured result (mA) (max. value)	45.2	14.2	17.1	28.3	48.2	108.7
Pn[%]	60%Pn	70%Pn	80%Pn	90%Pn	100%Pn	Limited
d.c. current measured result (mA) (max. value)	40.6	50.4	99.5	54.4	46.4	108.7

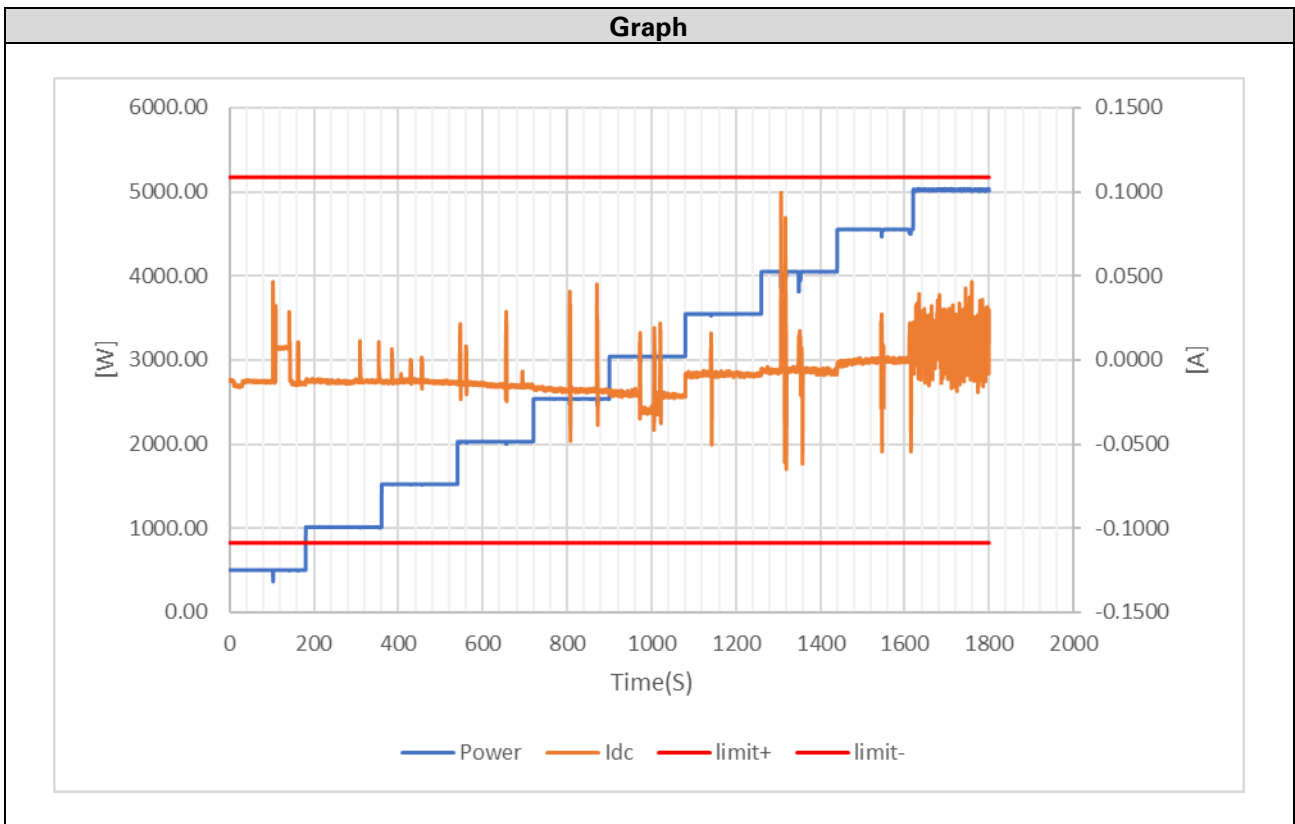

Model: LXP 3K Hybrid						
Measured protection time when d.c. current over 0.5%In						
Pn[%]	10%Pn	20%Pn	30%Pn	40%Pn	50%Pn	Limited
Disconnection time(ms)	422.28	445.28	477.28	494.28	383.28	500
Pn[%]	60%Pn	70%Pn	80%Pn	90%Pn	100%Pn	Limited
Disconnection time(ms)	366.28	437.28	347.28	388.28	436.28	500

Figure

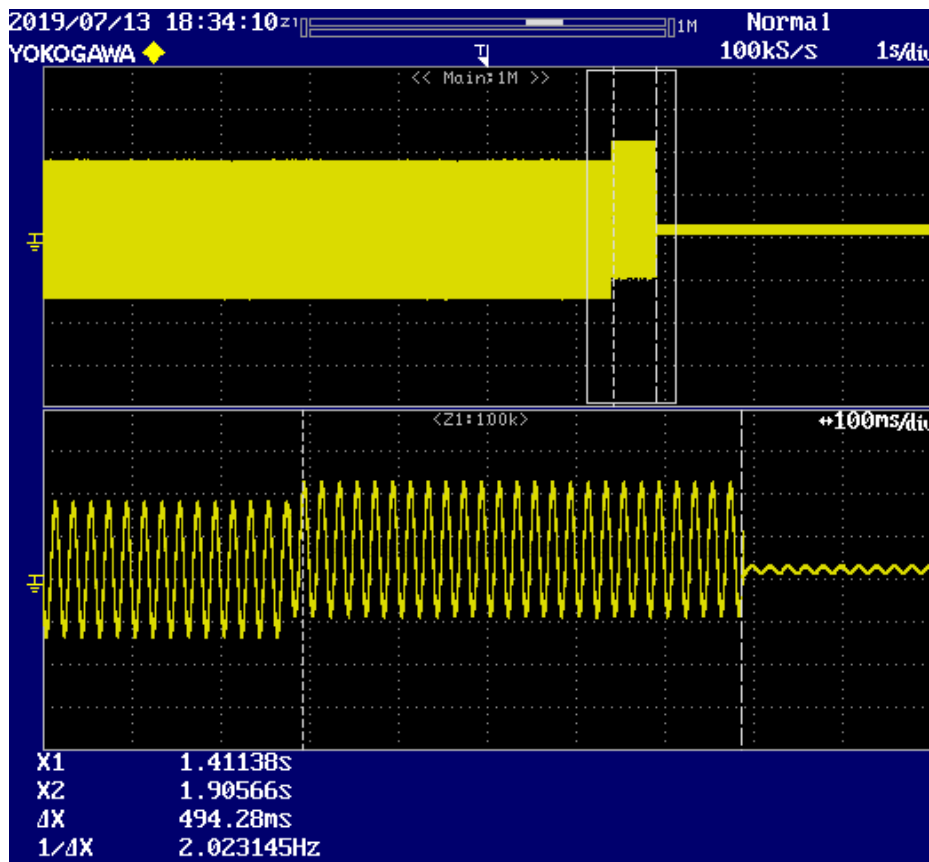

Model: LXP 5K Hybrid						
Measured protection time when d.c. current over 0.5In						
Pn[%]	10%Pn	20%Pn	30%Pn	40%Pn	50%Pn	Limited
Disconnection time(ms)	481.28	491.28	403.28	455.28	484.28	500
Pn[%]	60%Pn	70%Pn	80%Pn	90%Pn	100%Pn	Limited
Disconnection time(ms)	424.28	402.28	381.28	460.28	445.28	500

Figure

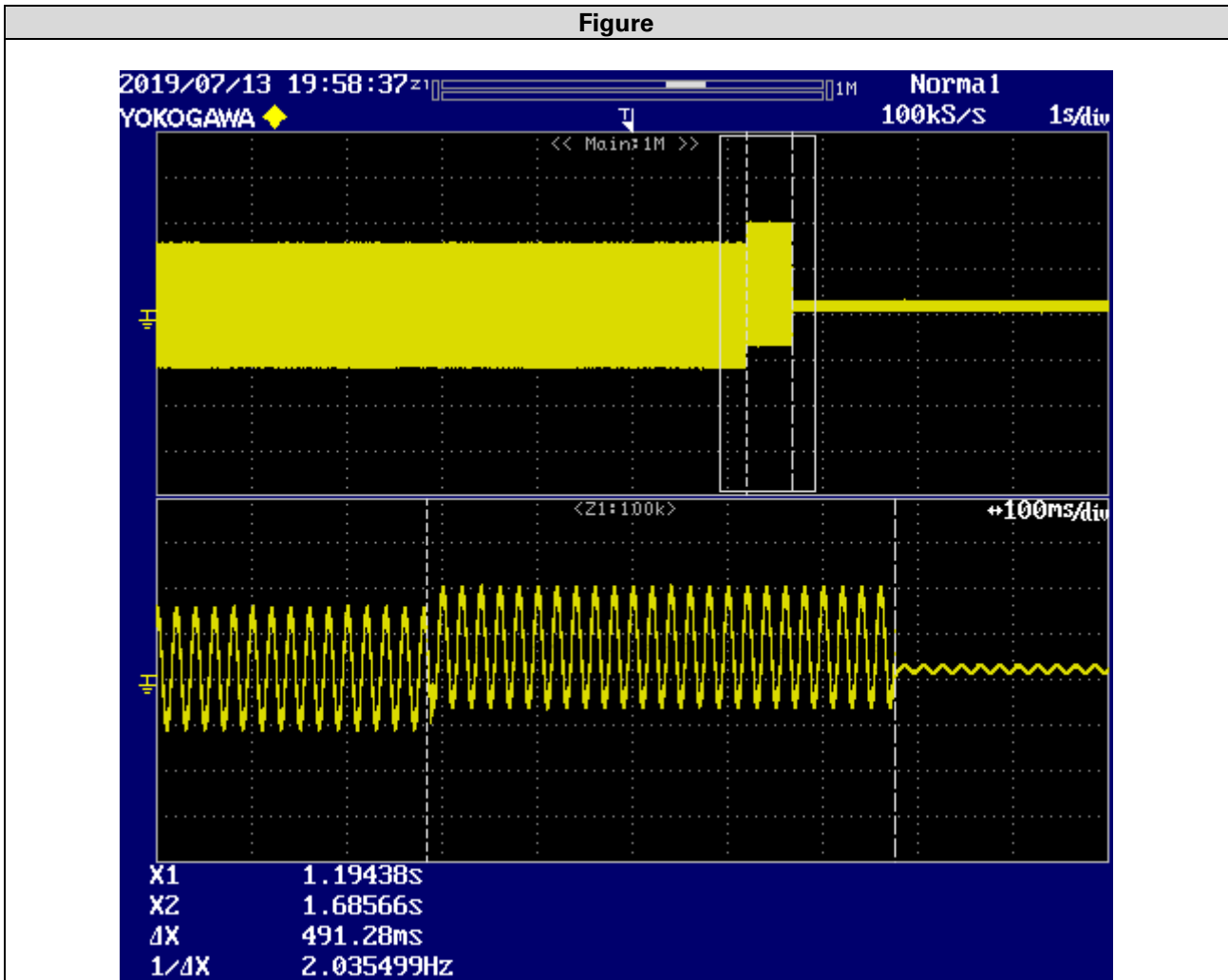

4.1.10	Table: Harmonics and waveform distortion					P
Table 1 — Maximum harmonic current distortion as percentage of rated current						
1	2	3	4	5	6	
Harmonic order (h)	h<11	11≤h<17	17≤h<23	23≤h<35	35≤h	
Percentage of rated current (Odd harmonics)	4,0	2,0	1,5	0,6	0,3	
Percentage of rated current (Even harmonics)	1,0	0,5	0,38	0,15	0,08	
Percentage of rated current (Inter-harmonics)	0,1	0,25	0,19	0,08	0,03	
Total Demand Distortion = 5%						
<p>NOTE 1 Even harmonics are limited to 25 % of the odd harmonic limits</p> <p>NOTE 2 Inter-harmonic are limited to 25 % of the odd harmonic limits and adjusted for the 200 Hz band measurement required by IEC 61000-4-7, except for the lower frequencies where the flicker contribution is more likely.</p> <p>NOTE 3 Total Demand Distortion = Total Harmonic Distortion</p>						

Model: LXP 3K Hybrid												LIMIT (%)
Pn(%)	0	10	20	30	40	50	60	70	80	90	100	
Nr. /Order	I _h (%)	I _h (%)	I _h (%)	I _h (%)	I _h (%)	I _h (%)	I _h (%)	I _h (%)	I _h (%)	I _h (%)	I _h (%)	
2	0.00	0.0727	0.1146	0.1111	0.0955	0.1085	0.1202	0.1271	0.1412	0.1679	0.1689	1
3	0.00	0.4127	0.2608	0.7152	0.7339	0.7655	0.7839	0.8235	0.8647	0.8843	0.9385	4
4	0.00	0.3665	0.4283	0.1410	0.4307	0.4291	0.4496	0.4473	0.4736	0.4696	0.4957	1
5	0.00	0.2694	0.1071	0.4636	0.4911	0.5063	0.5269	0.5416	0.5574	0.5810	0.5854	4
6	0.00	0.1641	0.2000	0.1155	0.1894	0.1973	0.1837	0.1877	0.1850	0.1778	0.1827	1
7	0.00	0.2777	0.1407	0.3876	0.4331	0.3867	0.3730	0.3668	0.3488	0.3337	0.3232	4
8	0.00	0.1240	0.1314	0.0508	0.1336	0.1159	0.1140	0.1088	0.1178	0.1128	0.0986	1
9	0.00	0.1981	0.1347	0.4049	0.4133	0.4617	0.4876	0.4954	0.4885	0.5020	0.5081	4
10	0.00	0.0825	0.0887	0.0653	0.0527	0.0466	0.0435	0.0394	0.0468	0.0437	0.0404	1
11	0.00	0.0714	0.1408	0.3493	0.3246	0.2636	0.2435	0.2323	0.2506	0.2514	0.2490	2
12	0.00	0.0653	0.1070	0.0808	0.0833	0.0710	0.0681	0.0697	0.0730	0.0649	0.0551	0.5
13	0.00	0.1162	0.1302	0.3497	0.3140	0.3536	0.3580	0.3523	0.3451	0.3420	0.3734	2
14	0.00	0.0641	0.0867	0.0511	0.0658	0.0712	0.0658	0.0593	0.0706	0.0626	0.0627	0.5
15	0.00	0.1854	0.0860	0.1408	0.2178	0.1830	0.1877	0.2023	0.2119	0.2244	0.2004	2
16	0.00	0.0634	0.0735	0.0435	0.0562	0.0619	0.0418	0.0517	0.0487	0.0494	0.0520	0.5
17	0.00	0.2218	0.0958	0.2603	0.2694	0.2597	0.2535	0.2395	0.2379	0.2342	0.2311	1.5
18	0.00	0.0795	0.0773	0.0288	0.0568	0.0620	0.0485	0.0453	0.0548	0.0496	0.0582	0.38
19	0.00	0.2344	0.1070	0.1467	0.0746	0.0845	0.0943	0.0981	0.1053	0.1143	0.1349	1.5
20	0.00	0.0529	0.0774	0.0472	0.0514	0.0601	0.0392	0.0409	0.0396	0.0451	0.0436	0.38
21	0.00	0.2520	0.1347	0.1150	0.1768	0.1445	0.1356	0.1275	0.1238	0.1248	0.1167	1.5
22	0.00	0.0409	0.0534	0.0278	0.0473	0.0491	0.0510	0.0511	0.0500	0.0582	0.0558	0.38
23	0.00	0.2581	0.1631	0.0933	0.0959	0.0773	0.0905	0.1141	0.1095	0.0931	0.0911	0.6
24	0.00	0.0348	0.0506	0.0309	0.0428	0.0406	0.0422	0.0421	0.0398	0.0433	0.0534	0.15
25	0.00	0.2195	0.1714	0.0657	0.1034	0.0880	0.0741	0.0685	0.0667	0.0894	0.0857	0.6
26	0.00	0.0323	0.0454	0.0242	0.0386	0.0279	0.0309	0.0350	0.0420	0.0355	0.0341	0.15
27	0.00	0.1674	0.1640	0.0996	0.1367	0.1456	0.1435	0.1422	0.1179	0.1172	0.1077	0.6
28	0.00	0.0242	0.0373	0.0330	0.0367	0.0352	0.0355	0.0321	0.0502	0.0440	0.0394	0.15
29	0.00	0.1124	0.1614	0.0677	0.0318	0.0459	0.0534	0.0506	0.0514	0.0436	0.0537	0.6
30	0.00	0.0193	0.0410	0.0191	0.0391	0.0397	0.0356	0.0340	0.0317	0.0324	0.0350	0.15
31	0.00	0.0652	0.1404	0.0812	0.1025	0.0994	0.0880	0.0911	0.0936	0.1166	0.1127	0.6
32	0.00	0.0172	0.0366	0.0151	0.0300	0.0300	0.0321	0.0271	0.0333	0.0351	0.0335	0.15
33	0.00	0.0195	0.1169	0.1041	0.0817	0.0938	0.0891	0.0873	0.0805	0.0642	0.0644	0.6
34	0.00	0.0183	0.0340	0.0169	0.0319	0.0340	0.0311	0.0318	0.0307	0.0309	0.0361	0.15
35	0.00	0.0261	0.0970	0.0283	0.0541	0.0498	0.0420	0.0596	0.0681	0.0909	0.0908	0.3
36	0.00	0.0196	0.0279	0.0171	0.0330	0.0345	0.0318	0.0266	0.0279	0.0286	0.0304	0.08
37	0.00	0.0544	0.0786	0.0949	0.0968	0.0847	0.0821	0.0852	0.0772	0.0814	0.0806	0.3
38	0.00	0.0204	0.0297	0.0171	0.0235	0.0262	0.0216	0.0202	0.0246	0.0250	0.0261	0.08
39	0.00	0.0734	0.0603	0.0207	0.0253	0.0332	0.0326	0.0348	0.0435	0.0430	0.0421	0.3
40	0.00	0.0213	0.0209	0.0119	0.0262	0.0256	0.0218	0.0226	0.0258	0.0258	0.0252	0.08
41	0.00	0.0886	0.0479	0.0816	0.0799	0.0647	0.0629	0.0576	0.0527	0.0722	0.0844	0.3
42	0.00	0.0273	0.0224	0.0118	0.0299	0.0312	0.0290	0.0337	0.0293	0.0320	0.0310	0.08
43	0.00	0.0833	0.0349	0.0428	0.0487	0.0553	0.0560	0.0579	0.0435	0.0311	0.0297	0.3
44	0.00	0.0354	0.0347	0.0179	0.0516	0.0524	0.0530	0.0550	0.0548	0.0572	0.0604	0.08
45	0.00	0.0803	0.0327	0.0444	0.0543	0.0397	0.0440	0.0382	0.0436	0.0582	0.0609	0.3
46	0.00	0.0328	0.0339	0.0175	0.0487	0.0513	0.0518	0.0516	0.0530	0.0562	0.0556	0.08
47	0.00	0.0679	0.0231	0.0650	0.0703	0.0752	0.0681	0.0568	0.0500	0.0394	0.0383	0.3
48	0.00	0.0247	0.0217	0.0209	0.0335	0.0303	0.0326	0.0343	0.0296	0.0309	0.0305	0.08
49	0.00	0.0540	0.0247	0.0102	0.0195	0.0218	0.0238	0.0290	0.0356	0.0363	0.0383	0.3
50	0.00	0.0166	0.0205	0.0159	0.0238	0.0246	0.0250	0.0188	0.0225	0.0195	0.0192	0.08
THD(%)	0.00	4.8900	4.5700	4.3700	3.6400	2.8900	2.5000	2.1100	2.0600	1.8900	1.6100	5

P/Pn[%]	0	10	20	30	40	50	60	70	80	90	100	LIMIT
[Hz]	I _h (%)	I _h (%)	I _h (%)	I _h (%)	I _h (%)	I _h (%)	I _h (%)	I _h (%)	I _h (%)	I _h (%)	I _h (%)	(%)
75	0.00	0.0970	0.0877	0.0836	0.0813	0.0811	0.0755	0.0765	0.0683	0.0707	0.0629	0.1
125	0.00	0.0412	0.0371	0.0394	0.0412	0.0405	0.0393	0.0387	0.0400	0.0383	0.0427	0.1
175	0.00	0.0396	0.0357	0.0365	0.0365	0.0360	0.0355	0.0348	0.0345	0.0230	0.0366	0.1
225	0.00	0.0402	0.0372	0.0380	0.0378	0.0370	0.0360	0.0361	0.0358	0.0383	0.0376	0.1
275	0.00	0.0387	0.0379	0.0383	0.0379	0.0377	0.0380	0.0390	0.0365	0.0153	0.0376	0.1
325	0.00	0.0401	0.0379	0.0390	0.0394	0.0395	0.0381	0.0391	0.0378	0.0460	0.0381	0.1
375	0.00	0.0388	0.0399	0.0384	0.0386	0.0396	0.0401	0.0396	0.0381	0.0383	0.0380	0.1
425	0.00	0.0375	0.0422	0.0390	0.0399	0.0407	0.0402	0.0403	0.0381	0.0383	0.0385	0.1
475	0.00	0.0364	0.0410	0.0389	0.0392	0.0413	0.0397	0.0392	0.0392	0.0383	0.0394	0.1
525	0.00	0.0355	0.0418	0.0395	0.0400	0.0404	0.0404	0.0407	0.0384	0.0307	0.0394	0.1
575	0.00	0.0378	0.0418	0.0400	0.0414	0.0417	0.0410	0.0417	0.0408	0.0460	0.0403	0.25
625	0.00	0.0388	0.0414	0.0415	0.0416	0.0415	0.0415	0.0421	0.0410	0.0383	0.0408	0.25
675	0.00	0.0379	0.0426	0.0421	0.0433	0.0428	0.0433	0.0421	0.0420	0.0537	0.0416	0.25
725	0.00	0.0377	0.0424	0.0437	0.0422	0.0443	0.0435	0.0440	0.0437	0.0460	0.0430	0.25
775	0.00	0.0401	0.0443	0.0435	0.0456	0.0442	0.0444	0.0441	0.0439	0.0613	0.0426	0.25
825	0.00	0.0384	0.0445	0.0443	0.0451	0.0458	0.0464	0.0452	0.0456	0.0690	0.0444	0.25
875	0.00	0.0398	0.0440	0.0441	0.0465	0.0469	0.0467	0.0475	0.0462	0.0383	0.0457	0.19
925	0.00	0.0398	0.0433	0.0448	0.0456	0.0460	0.0455	0.0463	0.0458	0.0307	0.0456	0.19
975	0.00	0.0367	0.0421	0.0438	0.0450	0.0469	0.0462	0.0463	0.0472	0.0537	0.0476	0.19
1025	0.00	0.0382	0.0420	0.0435	0.0446	0.0462	0.0469	0.0472	0.0467	0.0460	0.0460	0.19
1075	0.00	0.0357	0.0410	0.0423	0.0440	0.0449	0.0460	0.0454	0.0457	0.0460	0.0461	0.19
1125	0.00	0.0362	0.0388	0.0397	0.0420	0.0440	0.0441	0.0443	0.0451	0.0383	0.0459	0.19
1175	0.00	0.0335	0.0380	0.0391	0.0413	0.0411	0.0438	0.0426	0.0435	0.0307	0.0447	0.08
1225	0.00	0.0330	0.0371	0.0378	0.0393	0.0395	0.0412	0.0422	0.0419	0.0460	0.0437	0.08
1275	0.00	0.0305	0.0339	0.0360	0.0371	0.0392	0.0389	0.0402	0.0406	0.0460	0.0418	0.08
1325	0.00	0.0303	0.0326	0.0344	0.0368	0.0377	0.0372	0.0384	0.0405	0.0460	0.0410	0.08
1375	0.00	0.0281	0.0306	0.0321	0.0346	0.0355	0.0353	0.0383	0.0377	0.0460	0.0392	0.08
1425	0.00	0.0270	0.0294	0.0307	0.0325	0.0336	0.0348	0.0346	0.0364	0.0383	0.0375	0.08
1475	0.00	0.0258	0.0275	0.0293	0.0313	0.0317	0.0327	0.0344	0.0335	0.0230	0.0359	0.08
1525	0.00	0.0249	0.0267	0.0284	0.0300	0.0303	0.0310	0.0315	0.0326	0.0230	0.0354	0.08
1575	0.00	0.0240	0.0257	0.0263	0.0282	0.0297	0.0303	0.0316	0.0332	0.0383	0.0347	0.08
1625	0.00	0.0231	0.0244	0.0260	0.0271	0.0276	0.0288	0.0298	0.0316	0.0383	0.0325	0.08
1675	0.00	0.0217	0.0237	0.0244	0.0260	0.0270	0.0286	0.0287	0.0309	0.0307	0.0329	0.08
1725	0.00	0.0215	0.0231	0.0242	0.0257	0.0262	0.0269	0.0287	0.0299	0.0307	0.0312	0.08
1775	0.00	0.0202	0.0213	0.0233	0.0251	0.0259	0.0276	0.0283	0.0286	0.0207	0.0212	0.03
1825	0.00	0.0201	0.0218	0.0232	0.0242	0.0248	0.0255	0.0274	0.0275	0.0230	0.0207	0.03
1875	0.00	0.0206	0.0207	0.0218	0.0235	0.0245	0.0245	0.0271	0.0272	0.0283	0.0204	0.03
1925	0.00	0.0193	0.0199	0.0222	0.0232	0.0232	0.0248	0.0257	0.0271	0.0230	0.0285	0.03
1975	0.00	0.0189	0.0192	0.0219	0.0222	0.0226	0.0249	0.0255	0.0265	0.0277	0.0287	0.03
2025	0.00	0.0193	0.0187	0.0201	0.0216	0.0226	0.0236	0.0243	0.0255	0.0217	0.0277	0.03
2075	0.00	0.0181	0.0187	0.0207	0.0215	0.0226	0.0229	0.0240	0.0247	0.0207	0.0267	0.03
2125	0.00	0.0181	0.0187	0.0200	0.0211	0.0222	0.0223	0.0246	0.0242	0.0230	0.0273	0.03
2175	0.00	0.0179	0.0184	0.0200	0.0209	0.0219	0.0224	0.0246	0.0244	0.0230	0.0262	0.03
2225	0.00	0.0179	0.0189	0.0212	0.0213	0.0223	0.0226	0.0248	0.0244	0.0230	0.0274	0.03
2275	0.00	0.0178	0.0186	0.0199	0.0199	0.0211	0.0213	0.0233	0.0234	0.0207	0.0252	0.03
2325	0.00	0.0185	0.0191	0.0194	0.0204	0.0209	0.0218	0.0228	0.0236	0.0153	0.0253	0.03
2375	0.00	0.0179	0.0168	0.0178	0.0185	0.0196	0.0207	0.0212	0.0228	0.0230	0.0243	0.03
2425	0.00	0.0174	0.0179	0.0182	0.0194	0.0198	0.0202	0.0206	0.0218	0.0230	0.0236	0.03
2475	0.00	0.0176	0.0164	0.0171	0.0178	0.0186	0.0193	0.0210	0.0206	0.0230	0.0233	0.03
2525	0.00	0.0171	0.0160	0.0168	0.0178	0.0177	0.0192	0.0194	0.0203	0.0153	0.0217	0.03
2575	0.00	0.0182	0.0166	0.0166	0.0183	0.0176	0.0185	0.0198	0.0210	0.0207	0.0229	0.03
2625	0.00	0.0160	0.0157	0.0172	0.0167	0.0177	0.0180	0.0190	0.0204	0.0153	0.0217	0.03
2675	0.00	0.0216	0.0209	0.0257	0.0239	0.0243	0.0230	0.0242	0.0237	0.0153	0.0272	0.03
2725	0.00	0.0167	0.0160	0.0161	0.0173	0.0164	0.0174	0.0179	0.0190	0.0153	0.0214	0.03
2775	0.00	0.0165	0.0156	0.0162	0.0169	0.0169	0.0178	0.0179	0.0187	0.0153	0.0207	0.03
2825	0.00	0.0164	0.0153	0.0156	0.0162	0.0160	0.0170	0.0171	0.0175	0.0153	0.0203	0.03
2875	0.00	0.0196	0.0168	0.0154	0.0166	0.0164	0.0169	0.0172	0.0181	0.0230	0.0200	0.03
2925	0.00	0.0158	0.0160	0.0152	0.0158	0.0165	0.0169	0.0167	0.0184	0.0230	0.0196	0.03
2975	0.00	0.0174	0.0155	0.0153	0.0158	0.0169	0.0178	0.0176	0.0183	0.0202	0.0200	0.03
3025	0.00	0.0185	0.0162	0.0155	0.0158	0.0167	0.0173	0.0174	0.0181	0.0231	0.0202	0.03

Model: LXP 4K Hybrid												LIMIT (%)
Pn(%)	0	10	20	30	40	50	60	70	80	90	100	
Nr. /Order	I _h (%)	I _h (%)	I _h (%)	I _h (%)	I _h (%)	I _h (%)	I _h (%)	I _h (%)	I _h (%)	I _h (%)	I _h (%)	
2	0.00	0.6896	0.3301	0.3220	0.3216	0.3247	0.3094	0.3027	0.2895	0.2825	0.2749	1
3	0.00	0.0704	0.0969	0.1459	0.1972	0.2442	0.2750	0.3244	0.3859	0.4502	0.5206	4
4	0.00	0.3560	0.3124	0.3428	0.3500	0.3772	0.3891	0.4201	0.4366	0.4719	0.5130	1
5	0.00	0.1024	0.1087	0.1275	0.1477	0.1648	0.1898	0.1947	0.2131	0.2302	0.2562	4
6	0.00	0.1830	0.0399	0.0485	0.0381	0.0496	0.0508	0.0587	0.0568	0.0655	0.0716	1
7	0.00	0.1382	0.0721	0.0682	0.0866	0.0852	0.0960	0.1023	0.1190	0.1194	0.1288	4
8	0.00	0.1613	0.1138	0.1310	0.1284	0.1295	0.1268	0.1275	0.1211	0.1207	0.1185	1
9	0.00	0.0891	0.0690	0.0751	0.0903	0.1088	0.1135	0.1032	0.1054	0.1277	0.1522	4
10	0.00	0.0853	0.0514	0.0666	0.0716	0.0712	0.0774	0.0835	0.0874	0.0813	0.0769	1
11	0.00	0.0666	0.0603	0.0761	0.0928	0.1153	0.1300	0.1434	0.1484	0.1431	0.1647	2
12	0.00	0.0785	0.0418	0.0715	0.0702	0.0712	0.0744	0.0696	0.0659	0.0616	0.0599	0.5
13	0.00	0.0270	0.0440	0.0523	0.0745	0.0713	0.0845	0.0799	0.0993	0.1156	0.1108	2
14	0.00	0.1219	0.0237	0.0383	0.0601	0.0584	0.0682	0.0740	0.0758	0.0784	0.0824	0.5
15	0.00	0.0518	0.0518	0.0386	0.0614	0.0959	0.0952	0.0845	0.0996	0.1220	0.1165	2
16	0.00	0.0802	0.0252	0.0285	0.0365	0.0255	0.0275	0.0239	0.0267	0.0246	0.0255	0.5
17	0.00	0.0899	0.0421	0.0337	0.0361	0.0557	0.0620	0.0651	0.0750	0.0786	0.1075	1.5
18	0.00	0.1105	0.0310	0.0360	0.0440	0.0580	0.0555	0.0698	0.0655	0.0674	0.0587	0.38
19	0.00	0.0958	0.0430	0.0323	0.0394	0.0523	0.0622	0.0564	0.0671	0.0842	0.0891	1.5
20	0.00	0.0996	0.0261	0.0270	0.0263	0.0275	0.0266	0.0301	0.0254	0.0311	0.0258	0.38
21	0.00	0.1255	0.0594	0.0268	0.0296	0.0301	0.0426	0.0332	0.0337	0.0469	0.0672	1.5
22	0.00	0.0544	0.0410	0.0258	0.0316	0.0308	0.0383	0.0373	0.0383	0.0327	0.0441	0.38
23	0.00	0.1191	0.0706	0.0376	0.0313	0.0401	0.0307	0.0345	0.0343	0.0309	0.0401	0.6
24	0.00	0.0823	0.0230	0.0222	0.0252	0.0273	0.0263	0.0360	0.0296	0.0399	0.0298	0.15
25	0.00	0.1190	0.0770	0.0376	0.0350	0.0321	0.0325	0.0286	0.0286	0.0335	0.0315	0.6
26	0.00	0.0562	0.0266	0.0236	0.0218	0.0237	0.0240	0.0249	0.0245	0.0223	0.0242	0.15
27	0.00	0.0986	0.0754	0.0371	0.0318	0.0325	0.0357	0.0358	0.0340	0.0368	0.0328	0.6
28	0.00	0.0522	0.0210	0.0191	0.0215	0.0212	0.0221	0.0218	0.0261	0.0252	0.0316	0.15
29	0.00	0.0743	0.0676	0.0383	0.0333	0.0375	0.0260	0.0291	0.0281	0.0300	0.0426	0.6
30	0.00	0.0398	0.0224	0.0169	0.0172	0.0178	0.0186	0.0186	0.0205	0.0217	0.0214	0.15
31	0.00	0.0558	0.0634	0.0352	0.0336	0.0326	0.0325	0.0395	0.0341	0.0334	0.0421	0.6
32	0.00	0.0257	0.0143	0.0182	0.0160	0.0177	0.0214	0.0200	0.0211	0.0188	0.0235	0.15
33	0.00	0.0355	0.0581	0.0378	0.0318	0.0309	0.0279	0.0265	0.0296	0.0262	0.0277	0.6
34	0.00	0.0218	0.0137	0.0144	0.0134	0.0143	0.0155	0.0168	0.0166	0.0179	0.0189	0.15
35	0.00	0.0242	0.0528	0.0368	0.0364	0.0323	0.0297	0.0328	0.0374	0.0342	0.0365	0.3
36	0.00	0.0222	0.0145	0.0128	0.0138	0.0143	0.0145	0.0160	0.0168	0.0160	0.0173	0.08
37	0.00	0.0222	0.0461	0.0383	0.0356	0.0280	0.0280	0.0284	0.0238	0.0268	0.0263	0.3
38	0.00	0.0232	0.0111	0.0123	0.0126	0.0157	0.0166	0.0172	0.0174	0.0216	0.0213	0.08
39	0.00	0.0244	0.0403	0.0385	0.0367	0.0326	0.0288	0.0318	0.0308	0.0357	0.0351	0.3
40	0.00	0.0244	0.0125	0.0131	0.0130	0.0135	0.0139	0.0147	0.0160	0.0182	0.0206	0.08
41	0.00	0.0259	0.0314	0.0359	0.0324	0.0267	0.0253	0.0241	0.0259	0.0268	0.0276	0.3
42	0.00	0.0278	0.0166	0.0187	0.0192	0.0199	0.0213	0.0242	0.0274	0.0292	0.0322	0.08
43	0.00	0.0295	0.0270	0.0346	0.0323	0.0284	0.0230	0.0201	0.0172	0.0176	0.0184	0.3
44	0.00	0.0335	0.0292	0.0329	0.0345	0.0365	0.0394	0.0438	0.0475	0.0520	0.0564	0.08
45	0.00	0.0301	0.0228	0.0375	0.0360	0.0317	0.0222	0.0215	0.0200	0.0203	0.0224	0.3
46	0.00	0.0415	0.0349	0.0375	0.0371	0.0382	0.0393	0.0410	0.0422	0.0431	0.0444	0.08
47	0.00	0.0268	0.0161	0.0335	0.0335	0.0285	0.0248	0.0207	0.0219	0.0246	0.0277	0.3
48	0.00	0.0369	0.0232	0.0235	0.0224	0.0230	0.0227	0.0226	0.0228	0.0228	0.0238	0.08
49	0.00	0.0237	0.0121	0.0322	0.0326	0.0294	0.0201	0.0221	0.0215	0.0236	0.0269	0.3
50	0.00	0.0291	0.0114	0.0127	0.0122	0.0134	0.0130	0.0148	0.0162	0.0183	0.0204	0.08
THD(%)	0.00	4.9785	3.0440	2.0550	1.6170	1.4050	1.2090	1.1090	1.0290	0.9870	0.9470	5

P/Pn[%]	0	10	20	30	40	50	60	70	80	90	100	LIMIT
[Hz]	I _h (%)	I _h (%)	I _h (%)	I _h (%)	I _h (%)	I _h (%)	I _h (%)	I _h (%)	I _h (%)	I _h (%)	I _h (%)	(%)
75	0.00	0.0737	0.0757	0.0886	0.0917	0.0883	0.0972	0.0876	0.0831	0.0895	0.0910	0.1
125	0.00	0.0299	0.0299	0.0304	0.0295	0.0324	0.0311	0.0338	0.0319	0.0319	0.0299	0.1
175	0.00	0.0291	0.0264	0.0271	0.0273	0.0298	0.0277	0.0284	0.0279	0.0266	0.0263	0.1
225	0.00	0.0294	0.0282	0.0275	0.0275	0.0296	0.0268	0.0288	0.0277	0.0272	0.0274	0.1
275	0.00	0.0316	0.0281	0.0282	0.0282	0.0309	0.0282	0.0291	0.0279	0.0283	0.0281	0.1
325	0.00	0.0302	0.0298	0.0284	0.0294	0.0300	0.0285	0.0291	0.0281	0.0283	0.0282	0.1
375	0.00	0.0300	0.0290	0.0291	0.0299	0.0295	0.0297	0.0284	0.0292	0.0287	0.0283	0.1
425	0.00	0.0294	0.0305	0.0293	0.0309	0.0306	0.0293	0.0298	0.0289	0.0292	0.0294	0.1
475	0.00	0.0298	0.0303	0.0297	0.0298	0.0305	0.0301	0.0294	0.0293	0.0276	0.0284	0.1
525	0.00	0.0295	0.0304	0.0296	0.0310	0.0312	0.0303	0.0302	0.0293	0.0291	0.0286	0.1
575	0.00	0.0295	0.0309	0.0303	0.0312	0.0316	0.0305	0.0291	0.0310	0.0284	0.0286	0.25
625	0.00	0.0296	0.0324	0.0315	0.0314	0.0321	0.0311	0.0314	0.0304	0.0298	0.0289	0.25
675	0.00	0.0307	0.0322	0.0322	0.0320	0.0323	0.0328	0.0309	0.0303	0.0315	0.0299	0.25
725	0.00	0.0308	0.0312	0.0317	0.0328	0.0331	0.0324	0.0321	0.0319	0.0307	0.0311	0.25
775	0.00	0.0322	0.0326	0.0334	0.0347	0.0339	0.0333	0.0327	0.0325	0.0317	0.0312	0.25
825	0.00	0.0317	0.0331	0.0340	0.0344	0.0345	0.0336	0.0345	0.0330	0.0327	0.0323	0.25
875	0.00	0.0327	0.0330	0.0348	0.0344	0.0350	0.0342	0.0334	0.0339	0.0330	0.0325	0.19
925	0.00	0.0315	0.0340	0.0351	0.0351	0.0350	0.0358	0.0346	0.0335	0.0332	0.0335	0.19
975	0.00	0.0314	0.0325	0.0352	0.0353	0.0355	0.0362	0.0357	0.0337	0.0343	0.0324	0.19
1025	0.00	0.0309	0.0329	0.0342	0.0352	0.0358	0.0351	0.0342	0.0346	0.0343	0.0334	0.19
1075	0.00	0.0298	0.0306	0.0331	0.0334	0.0352	0.0341	0.0339	0.0334	0.0350	0.0334	0.19
1125	0.00	0.0283	0.0305	0.0323	0.0328	0.0349	0.0334	0.0325	0.0330	0.0338	0.0332	0.19
1175	0.00	0.0270	0.0288	0.0318	0.0316	0.0330	0.0345	0.0335	0.0320	0.0335	0.0322	0.08
1225	0.00	0.0262	0.0281	0.0301	0.0307	0.0319	0.0317	0.0317	0.0325	0.0330	0.0322	0.08
1275	0.00	0.0254	0.0265	0.0284	0.0297	0.0299	0.0312	0.0311	0.0307	0.0325	0.0305	0.08
1325	0.00	0.0234	0.0256	0.0273	0.0283	0.0299	0.0300	0.0302	0.0301	0.0311	0.0305	0.08
1375	0.00	0.0226	0.0235	0.0261	0.0260	0.0272	0.0281	0.0294	0.0293	0.0305	0.0293	0.08
1425	0.00	0.0216	0.0234	0.0244	0.0254	0.0273	0.0278	0.0279	0.0288	0.0289	0.0291	0.08
1475	0.00	0.0206	0.0217	0.0227	0.0248	0.0253	0.0265	0.0270	0.0269	0.0287	0.0280	0.08
1525	0.00	0.0197	0.0204	0.0219	0.0236	0.0239	0.0251	0.0258	0.0264	0.0271	0.0273	0.08
1575	0.00	0.0191	0.0199	0.0216	0.0224	0.0235	0.0247	0.0255	0.0267	0.0268	0.0261	0.08
1625	0.00	0.0184	0.0191	0.0199	0.0214	0.0225	0.0238	0.0248	0.0254	0.0262	0.0255	0.08
1675	0.00	0.0173	0.0180	0.0198	0.0208	0.0223	0.0236	0.0237	0.0256	0.0251	0.0266	0.08
1725	0.00	0.0164	0.0185	0.0189	0.0198	0.0210	0.0226	0.0231	0.0242	0.0250	0.0262	0.08
1775	0.00	0.0161	0.0171	0.0187	0.0198	0.0201	0.0217	0.0230	0.0237	0.0254	0.0249	0.03
1825	0.00	0.0158	0.0170	0.0175	0.0185	0.0205	0.0210	0.0223	0.0232	0.0248	0.0249	0.03
1875	0.00	0.0157	0.0161	0.0173	0.0180	0.0190	0.0211	0.0217	0.0234	0.0237	0.0235	0.03
1925	0.00	0.0147	0.0160	0.0173	0.0177	0.0188	0.0203	0.0211	0.0233	0.0237	0.0243	0.03
1975	0.00	0.0147	0.0156	0.0168	0.0176	0.0180	0.0205	0.0204	0.0217	0.0240	0.0233	0.03
2025	0.00	0.0136	0.0151	0.0159	0.0168	0.0176	0.0192	0.0207	0.0213	0.0233	0.0238	0.03
2075	0.00	0.0145	0.0151	0.0160	0.0167	0.0173	0.0183	0.0197	0.0219	0.0238	0.0233	0.03
2125	0.00	0.0138	0.0148	0.0161	0.0162	0.0170	0.0185	0.0194	0.0210	0.0225	0.0232	0.03
2175	0.00	0.0135	0.0147	0.0150	0.0165	0.0173	0.0189	0.0194	0.0218	0.0230	0.0233	0.03
2225	0.00	0.0144	0.0151	0.0159	0.0164	0.0178	0.0187	0.0192	0.0205	0.0223	0.0234	0.03
2275	0.00	0.0139	0.0145	0.0155	0.0159	0.0173	0.0179	0.0186	0.0205	0.0221	0.0226	0.03
2325	0.00	0.0142	0.0141	0.0148	0.0158	0.0164	0.0176	0.0183	0.0204	0.0224	0.0224	0.03
2375	0.00	0.0128	0.0130	0.0140	0.0148	0.0159	0.0177	0.0181	0.0194	0.0202	0.0224	0.03
2425	0.00	0.0133	0.0130	0.0140	0.0140	0.0147	0.0169	0.0175	0.0184	0.0204	0.0217	0.03
2475	0.00	0.0127	0.0124	0.0131	0.0139	0.0149	0.0157	0.0171	0.0183	0.0201	0.0214	0.03
2525	0.00	0.0126	0.0122	0.0128	0.0135	0.0141	0.0161	0.0171	0.0184	0.0199	0.0212	0.03
2575	0.00	0.0134	0.0125	0.0135	0.0139	0.0146	0.0153	0.0164	0.0179	0.0202	0.0222	0.03
2625	0.00	0.0120	0.0122	0.0123	0.0133	0.0136	0.0154	0.0160	0.0180	0.0186	0.0208	0.03
2675	0.00	0.0263	0.0205	0.0187	0.0173	0.0173	0.0194	0.0183	0.0210	0.0229	0.0281	0.03
2725	0.00	0.0120	0.0117	0.0127	0.0133	0.0134	0.0150	0.0157	0.0171	0.0187	0.0212	0.03
2775	0.00	0.0120	0.0120	0.0125	0.0134	0.0139	0.0144	0.0154	0.0173	0.0185	0.0211	0.03
2825	0.00	0.0116	0.0116	0.0121	0.0124	0.0131	0.0138	0.0146	0.0166	0.0174	0.0208	0.03
2875	0.00	0.0126	0.0120	0.0122	0.0126	0.0138	0.0137	0.0146	0.0168	0.0170	0.0196	0.03
2925	0.00	0.0112	0.0115	0.0117	0.0121	0.0134	0.0136	0.0144	0.0159	0.0174	0.0193	0.03
2975	0.00	0.0129	0.0120	0.0121	0.0121	0.0138	0.0135	0.0148	0.0170	0.0171	0.0196	0.03
3025	0.00	0.0124	0.0115	0.0122	0.0124	0.0134	0.0134	0.0145	0.0169	0.0172	0.0194	0.03

Model: LXP 5K Hybrid												LIMIT (%)
Pn(%)	0	10	20	30	40	50	60	70	80	90	100	
Nr. /Order	I _h (%)	I _h (%)	I _h (%)	I _h (%)	I _h (%)	I _h (%)	I _h (%)	I _h (%)	I _h (%)	I _h (%)	I _h (%)	
2	0.00	0.2595	0.2658	0.2638	0.2537	0.2458	0.2364	0.2208	0.2166	0.1094	0.2183	1
3	0.00	0.0632	0.0919	0.1503	0.1949	0.2403	0.2860	0.3498	0.4089	0.0247	0.5303	4
4	0.00	0.2201	0.2541	0.2767	0.3001	0.3139	0.3401	0.3694	0.3918	0.0218	0.4511	1
5	0.00	0.0773	0.0971	0.1093	0.1300	0.1503	0.1611	0.1768	0.1960	0.0220	0.2410	4
6	0.00	0.0278	0.0296	0.0285	0.0389	0.0358	0.0441	0.0506	0.0486	0.0232	0.0554	1
7	0.00	0.0527	0.0496	0.0554	0.0705	0.0829	0.0886	0.0960	0.1014	0.0230	0.1142	4
8	0.00	0.0611	0.0995	0.1014	0.1053	0.1031	0.0987	0.0958	0.0901	0.0233	0.0858	1
9	0.00	0.0496	0.0564	0.0596	0.0728	0.0822	0.0936	0.0985	0.1080	0.0232	0.1249	4
10	0.00	0.0470	0.0419	0.0606	0.0594	0.0598	0.0656	0.0631	0.0666	0.0237	0.0630	1
11	0.00	0.0231	0.0566	0.0864	0.0880	0.0911	0.0986	0.1189	0.1304	0.0240	0.1326	2
12	0.00	0.0175	0.0472	0.0558	0.0533	0.0602	0.0578	0.0493	0.0476	0.0240	0.0410	0.5
13	0.00	0.0201	0.0423	0.0576	0.0559	0.0658	0.0656	0.0819	0.0921	0.0238	0.1045	2
14	0.00	0.0391	0.0272	0.0396	0.0483	0.0569	0.0554	0.0662	0.0645	0.0237	0.0720	0.5
15	0.00	0.0339	0.0404	0.0492	0.0780	0.0658	0.0704	0.0915	0.0972	0.0242	0.1191	2
16	0.00	0.0210	0.0225	0.0300	0.0198	0.0229	0.0198	0.0214	0.0214	0.0255	0.0209	0.5
17	0.00	0.0433	0.0232	0.0387	0.0489	0.0409	0.0480	0.0695	0.0781	0.0248	0.0867	1.5
18	0.00	0.0397	0.0186	0.0345	0.0428	0.0489	0.0569	0.0498	0.0484	0.0257	0.0448	0.38
19	0.00	0.0694	0.0260	0.0236	0.0495	0.0431	0.0467	0.0582	0.0600	0.0260	0.0790	1.5
20	0.00	0.0219	0.0217	0.0205	0.0233	0.0213	0.0220	0.0205	0.0222	0.0266	0.0193	0.38
21	0.00	0.0879	0.0254	0.0218	0.0296	0.0308	0.0245	0.0309	0.0396	0.0282	0.0608	1.5
22	0.00	0.0388	0.0234	0.0239	0.0272	0.0259	0.0323	0.0288	0.0314	0.0271	0.0390	0.38
23	0.00	0.1024	0.0408	0.0258	0.0418	0.0247	0.0333	0.0263	0.0364	0.0264	0.0458	0.6
24	0.00	0.0186	0.0176	0.0214	0.0208	0.0235	0.0233	0.0278	0.0259	0.0265	0.0203	0.15
25	0.00	0.0936	0.0529	0.0201	0.0309	0.0230	0.0215	0.0247	0.0301	0.0257	0.0495	0.6
26	0.00	0.0213	0.0186	0.0167	0.0202	0.0196	0.0190	0.0193	0.0204	0.0258	0.0216	0.15
27	0.00	0.0776	0.0469	0.0201	0.0316	0.0239	0.0298	0.0248	0.0267	0.0247	0.0326	0.6
28	0.00	0.0130	0.0160	0.0151	0.0175	0.0188	0.0214	0.0207	0.0216	0.0241	0.0270	0.15
29	0.00	0.0603	0.0405	0.0281	0.0238	0.0263	0.0248	0.0197	0.0262	0.0236	0.0318	0.6
30	0.00	0.0125	0.0161	0.0128	0.0146	0.0145	0.0158	0.0173	0.0174	0.0227	0.0186	0.15
31	0.00	0.0514	0.0328	0.0337	0.0241	0.0282	0.0302	0.0290	0.0244	0.0222	0.0344	0.6
32	0.00	0.0100	0.0128	0.0145	0.0134	0.0165	0.0174	0.0161	0.0183	0.0215	0.0190	0.15
33	0.00	0.0366	0.0330	0.0327	0.0205	0.0247	0.0282	0.0189	0.0189	0.0218	0.0223	0.6
34	0.00	0.0103	0.0124	0.0117	0.0112	0.0123	0.0128	0.0144	0.0140	0.0214	0.0178	0.15
35	0.00	0.0246	0.0377	0.0297	0.0218	0.0257	0.0310	0.0239	0.0275	0.0216	0.0290	0.3
36	0.00	0.0119	0.0107	0.0113	0.0113	0.0118	0.0118	0.0120	0.0136	0.0217	0.0138	0.08
37	0.00	0.0157	0.0416	0.0282	0.0224	0.0233	0.0238	0.0200	0.0186	0.0197	0.0213	0.3
38	0.00	0.0105	0.0105	0.0110	0.0115	0.0128	0.0134	0.0151	0.0170	0.0200	0.0169	0.08
39	0.00	0.0189	0.0374	0.0253	0.0262	0.0232	0.0266	0.0265	0.0250	0.0200	0.0287	0.3
40	0.00	0.0099	0.0113	0.0103	0.0109	0.0125	0.0126	0.0141	0.0170	0.0196	0.0217	0.08
41	0.00	0.0184	0.0297	0.0230	0.0252	0.0175	0.0224	0.0197	0.0206	0.0196	0.0215	0.3
42	0.00	0.0111	0.0152	0.0147	0.0157	0.0176	0.0193	0.0226	0.0261	0.0198	0.0331	0.08
43	0.00	0.0195	0.0256	0.0240	0.0266	0.0141	0.0192	0.0113	0.0138	0.0207	0.0146	0.3
44	0.00	0.0196	0.0248	0.0268	0.0293	0.0324	0.0372	0.0412	0.0440	0.0210	0.0504	0.08
45	0.00	0.0272	0.0230	0.0302	0.0290	0.0171	0.0196	0.0161	0.0147	0.0202	0.0174	0.3
46	0.00	0.0249	0.0281	0.0291	0.0295	0.0325	0.0339	0.0344	0.0364	0.0199	0.0380	0.08
47	0.00	0.0287	0.0203	0.0297	0.0263	0.0147	0.0193	0.0171	0.0197	0.0206	0.0245	0.3
48	0.00	0.0194	0.0187	0.0185	0.0184	0.0182	0.0179	0.0183	0.0189	0.0199	0.0237	0.08
49	0.00	0.0316	0.0212	0.0305	0.0238	0.0132	0.0193	0.0163	0.0182	0.0196	0.0249	0.3
50	0.00	0.0098	0.0096	0.0108	0.0109	0.0111	0.0115	0.0141	0.0148	0.0194	0.0212	0.08
THD(%)	0.00	4.9070	2.4200	1.7150	1.3870	1.1760	1.0610	0.9900	0.9500	0.9200	0.9170	5

P/Pn[%]	0	10	20	30	40	50	60	70	80	90	100	LIMIT
[Hz]	I _h (%)	I _h (%)	I _h (%)	I _h (%)	I _h (%)	I _h (%)	I _h (%)	I _h (%)	I _h (%)	I _h (%)	I _h (%)	(%)
75	0.00	0.0563	0.0615	0.0662	0.0804	0.0906	0.0993	0.0930	0.0942	0.0894	0.0895	0.1
125	0.00	0.0229	0.0238	0.0238	0.0248	0.0260	0.0259	0.0260	0.0250	0.0247	0.0272	0.1
175	0.00	0.0223	0.0215	0.0218	0.0231	0.0231	0.0227	0.0228	0.0210	0.0218	0.0237	0.1
225	0.00	0.0236	0.0224	0.0221	0.0225	0.0225	0.0222	0.0227	0.0221	0.0220	0.0232	0.1
275	0.00	0.0234	0.0224	0.0231	0.0228	0.0229	0.0220	0.0230	0.0225	0.0232	0.0232	0.1
325	0.00	0.0244	0.0231	0.0230	0.0243	0.0234	0.0235	0.0226	0.0236	0.0230	0.0235	0.1
375	0.00	0.0236	0.0241	0.0235	0.0237	0.0233	0.0226	0.0237	0.0227	0.0233	0.0239	0.1
425	0.00	0.0237	0.0238	0.0242	0.0237	0.0230	0.0231	0.0229	0.0241	0.0232	0.0233	0.1
475	0.00	0.0231	0.0242	0.0238	0.0242	0.0241	0.0225	0.0234	0.0231	0.0237	0.0236	0.1
525	0.00	0.0228	0.0246	0.0242	0.0240	0.0236	0.0234	0.0233	0.0233	0.0240	0.0238	0.1
575	0.00	0.0236	0.0234	0.0255	0.0242	0.0243	0.0233	0.0233	0.0235	0.0240	0.0236	0.25
625	0.00	0.0230	0.0249	0.0246	0.0257	0.0251	0.0239	0.0241	0.0239	0.0238	0.0247	0.25
675	0.00	0.0247	0.0255	0.0255	0.0250	0.0245	0.0246	0.0248	0.0241	0.0237	0.0240	0.25
725	0.00	0.0238	0.0260	0.0257	0.0265	0.0256	0.0253	0.0251	0.0237	0.0242	0.0246	0.25
775	0.00	0.0243	0.0273	0.0268	0.0264	0.0261	0.0258	0.0257	0.0249	0.0255	0.0246	0.25
825	0.00	0.0248	0.0269	0.0268	0.0279	0.0269	0.0258	0.0257	0.0258	0.0248	0.0257	0.25
875	0.00	0.0248	0.0269	0.0263	0.0267	0.0273	0.0273	0.0261	0.0259	0.0257	0.0263	0.19
925	0.00	0.0247	0.0271	0.0275	0.0278	0.0276	0.0268	0.0268	0.0268	0.0260	0.0269	0.19
975	0.00	0.0243	0.0266	0.0281	0.0280	0.0273	0.0271	0.0270	0.0262	0.0266	0.0262	0.19
1025	0.00	0.0242	0.0264	0.0273	0.0273	0.0278	0.0274	0.0269	0.0270	0.0282	0.0263	0.19
1075	0.00	0.0232	0.0262	0.0265	0.0276	0.0278	0.0269	0.0259	0.0269	0.0271	0.0266	0.19
1125	0.00	0.0218	0.0250	0.0253	0.0259	0.0275	0.0259	0.0271	0.0264	0.0264	0.0269	0.19
1175	0.00	0.0216	0.0238	0.0246	0.0258	0.0261	0.0256	0.0259	0.0259	0.0265	0.0264	0.08
1225	0.00	0.0200	0.0238	0.0237	0.0254	0.0259	0.0255	0.0255	0.0255	0.0257	0.0256	0.08
1275	0.00	0.0190	0.0210	0.0234	0.0234	0.0249	0.0245	0.0243	0.0247	0.0258	0.0251	0.08
1325	0.00	0.0181	0.0206	0.0219	0.0233	0.0244	0.0233	0.0250	0.0247	0.0247	0.0246	0.08
1375	0.00	0.0168	0.0190	0.0210	0.0221	0.0225	0.0229	0.0231	0.0234	0.0241	0.0234	0.08
1425	0.00	0.0159	0.0189	0.0198	0.0209	0.0222	0.0223	0.0231	0.0230	0.0236	0.0241	0.08
1475	0.00	0.0151	0.0179	0.0190	0.0195	0.0204	0.0211	0.0216	0.0224	0.0227	0.0223	0.08
1525	0.00	0.0143	0.0172	0.0176	0.0182	0.0201	0.0213	0.0216	0.0216	0.0222	0.0218	0.08
1575	0.00	0.0136	0.0163	0.0177	0.0185	0.0193	0.0203	0.0216	0.0218	0.0215	0.0213	0.08
1625	0.00	0.0128	0.0156	0.0163	0.0178	0.0186	0.0199	0.0204	0.0212	0.0218	0.0217	0.08
1675	0.00	0.0122	0.0150	0.0159	0.0168	0.0182	0.0189	0.0200	0.0207	0.0214	0.0212	0.08
1725	0.00	0.0122	0.0143	0.0156	0.0169	0.0178	0.0184	0.0196	0.0199	0.0216	0.0212	0.08
1775	0.00	0.0117	0.0146	0.0149	0.0165	0.0172	0.0181	0.0192	0.0203	0.0217	0.0214	0.03
1825	0.00	0.0113	0.0141	0.0150	0.0156	0.0170	0.0177	0.0192	0.0193	0.0197	0.0201	0.03
1875	0.00	0.0113	0.0137	0.0146	0.0151	0.0162	0.0177	0.0183	0.0195	0.0200	0.0202	0.03
1925	0.00	0.0112	0.0131	0.0146	0.0151	0.0160	0.0170	0.0185	0.0188	0.0200	0.0201	0.03
1975	0.00	0.0106	0.0129	0.0139	0.0147	0.0155	0.0162	0.0179	0.0186	0.0196	0.0202	0.03
2025	0.00	0.0106	0.0125	0.0131	0.0145	0.0152	0.0164	0.0178	0.0190	0.0196	0.0199	0.03
2075	0.00	0.0101	0.0120	0.0131	0.0144	0.0158	0.0170	0.0177	0.0185	0.0198	0.0198	0.03
2125	0.00	0.0098	0.0117	0.0129	0.0143	0.0149	0.0159	0.0172	0.0190	0.0207	0.0205	0.03
2175	0.00	0.0102	0.0117	0.0126	0.0141	0.0152	0.0161	0.0171	0.0194	0.0210	0.0208	0.03
2225	0.00	0.0104	0.0118	0.0130	0.0143	0.0152	0.0156	0.0176	0.0193	0.0202	0.0209	0.03
2275	0.00	0.0102	0.0115	0.0122	0.0136	0.0141	0.0154	0.0170	0.0182	0.0199	0.0206	0.03
2325	0.00	0.0103	0.0114	0.0120	0.0133	0.0143	0.0161	0.0175	0.0186	0.0206	0.0210	0.03
2375	0.00	0.0093	0.0111	0.0115	0.0130	0.0134	0.0152	0.0159	0.0176	0.0199	0.0205	0.03
2425	0.00	0.0095	0.0104	0.0112	0.0120	0.0132	0.0140	0.0160	0.0174	0.0196	0.0210	0.03
2475	0.00	0.0091	0.0098	0.0105	0.0118	0.0128	0.0138	0.0158	0.0169	0.0194	0.0205	0.03
2525	0.00	0.0089	0.0097	0.0105	0.0116	0.0122	0.0144	0.0154	0.0169	0.0205	0.0213	0.03
2575	0.00	0.0100	0.0102	0.0109	0.0119	0.0119	0.0137	0.0151	0.0170	0.0200	0.0221	0.03
2625	0.00	0.0091	0.0095	0.0105	0.0103	0.0121	0.0137	0.0151	0.0167	0.0193	0.0221	0.03
2675	0.00	0.0190	0.0148	0.0143	0.0141	0.0143	0.0165	0.0183	0.0218	0.0255	0.010	0.03
2725	0.00	0.0084	0.0096	0.0098	0.0103	0.0116	0.0130	0.0140	0.0164	0.0193	0.0228	0.03
2775	0.00	0.0090	0.0098	0.0101	0.0108	0.0117	0.0132	0.0140	0.0168	0.0201	0.0244	0.03
2825	0.00	0.0082	0.0090	0.0097	0.0101	0.0117	0.0127	0.0137	0.0158	0.0182	0.0220	0.03
2875	0.00	0.0093	0.0094	0.0102	0.0104	0.0111	0.0128	0.0135	0.0151	0.0174	0.0210	0.03
2925	0.00	0.0084	0.0092	0.0094	0.0098	0.0109	0.0121	0.0132	0.0151	0.0178	0.0198	0.03
2975	0.00	0.0090	0.0091	0.0099	0.0105	0.0111	0.0126	0.0132	0.0151	0.0172	0.0203	0.03
3025	0.00	0.0092	0.0094	0.0098	0.0106	0.0111	0.0122	0.0133	0.0151	0.0175	0.0202	0.03

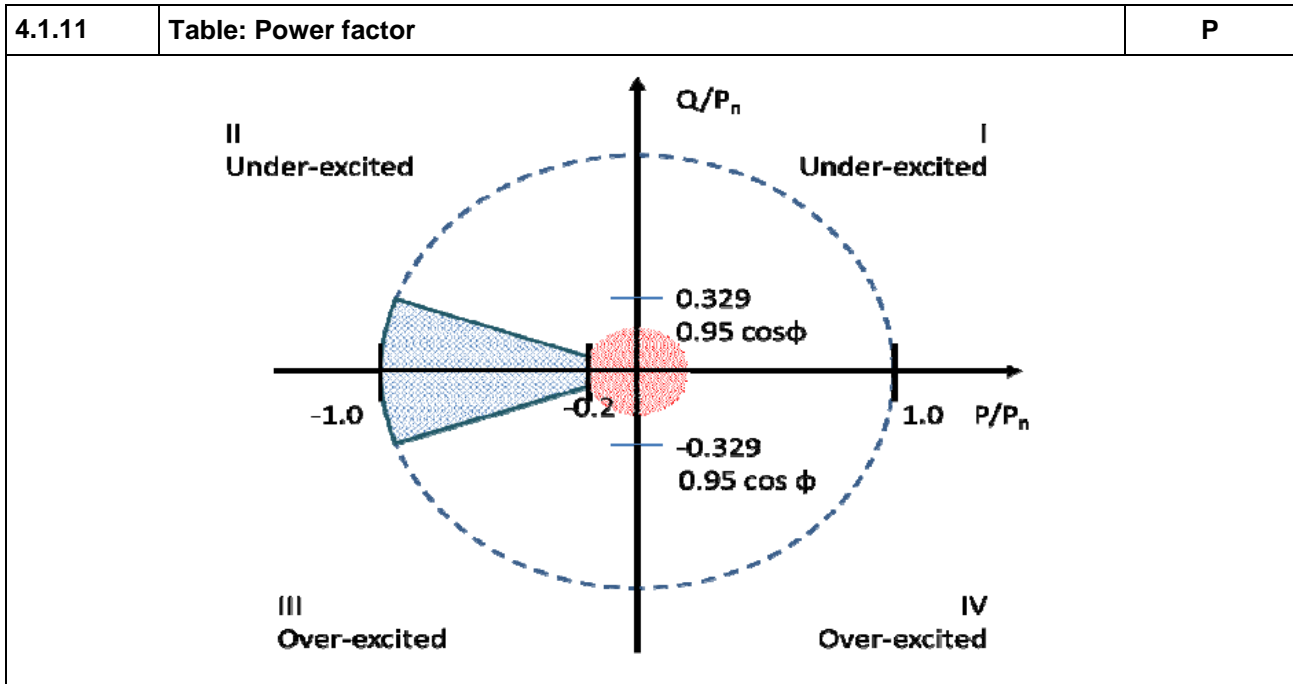

Model: LXP 5K Hybrid

Unity Power Factor (PF=1.0)

P/Pn[%] setpoint	P[W]	Q[Var]	Cosφ	Cosφ Set-point	Δcosφ	Q[Var] setpoint	ΔQ/P _n [%]	LIMITE ΔQ[%]
10	506.28	100.61	0.9804	1.00	-0.0196	--	--	--
20	1020.16	99.15	0.9952	1.00	-0.0048	0	1.98	5
30	1529.87	100.34	0.9978	1.00	-0.0022	0	2.01	5
40	2032.72	102.07	0.9987	1.00	-0.0013	0	2.04	5
50	2547.20	104.26	0.9991	1.00	-0.0009	0	2.09	5
60	3053.09	106.92	0.9994	1.00	-0.0006	0	2.14	5
70	3558.29	112.16	0.9995	1.00	-0.0005	0	2.24	5
80	4063.03	125.81	0.9995	1.00	-0.0005	0	2.52	5
90	4573.11	165.92	0.9993	1.00	-0.0007	0	3.32	5
100	5017.50	149.08	0.9995	1.00	-0.0005	0	2.98	5

Power Factor (PF=0.95 Inductive)

P/Pn[%] setpoint	P[W]	Q[Var]	Cosφ	Cosφ Set-point	Δcosφ	Q[Var] setpoint	ΔQ/P _n [%]	LIMITE ΔQ[%]
10	469.35	-114.69	0.9714	0.95	0.0214	--	--	--
20	976.50	-299.52	0.9560	0.95	0.0060	-328.68	0.58	5
30	1483.55	-469.52	0.9534	0.95	0.0034	-493.02	0.47	5
40	1984.95	-653.07	0.9499	0.95	-0.0001	-657.36	0.09	5
50	2491.44	-820.21	0.9498	0.95	-0.0002	-821.7	0.03	5
60	3008.80	-961.24	0.9526	0.95	0.0026	-986.04	0.50	5

70	3505.96	-1151.71	0.9501	0.95	0.0001	-1150.38	-0.03	5
80	3995.83	-1337.51	0.9483	0.95	-0.0017	-1314.72	-0.46	5
90	4497.79	-1512.91	0.9478	0.95	-0.0022	-1479.06	-0.68	5
100	5012.35	-1647.34	0.9471	0.95	-0.0029	-1643.4	-0.08	5

Power Factor (PF=0.95 Capacitive)								
P/Pn[%] setpoint	P[W]	Q[Var]	Cosφ	Cosφ Set-point	Δcosφ	Q[Var] setpoint	ΔQ/P _n [%]	LIMITE ΔQ[%]
10	527.81	195.07	0.9366	0.95	-0.0134	--	--	--
20	1057.58	347.94	0.9499	0.95	-0.0001	328.68	0.39	5
30	1568.78	499.06	0.9529	0.95	0.0029	493.02	0.12	5
40	2079.99	664.46	0.9526	0.95	0.0026	657.36	0.14	5
50	2480.23	790.05	0.9527	0.95	0.0027	821.7	-0.63	5
60	3090.93	1008.77	0.9506	0.95	0.0006	986.04	0.45	5
70	3606.34	1149.76	0.9528	0.95	0.0028	1150.38	-0.01	5
80	4112.92	1287.27	0.9543	0.95	0.0043	1314.72	-0.55	5
90	4630.34	1429.13	0.9555	0.95	0.0055	1479.06	-1.00	5
100	4998.99	1643.06	0.9500	0.95	0.0000	1643.4	-0.01	5

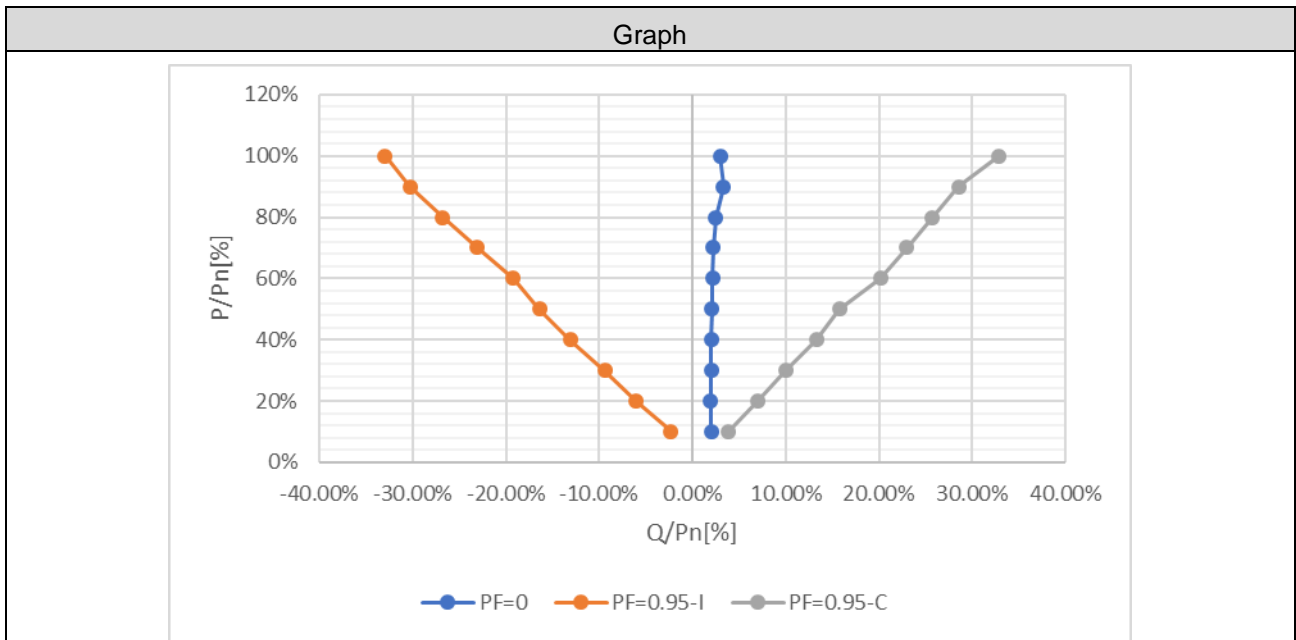

4.1.11.9	Table: Power factor characteristic curve	P
----------	--	---

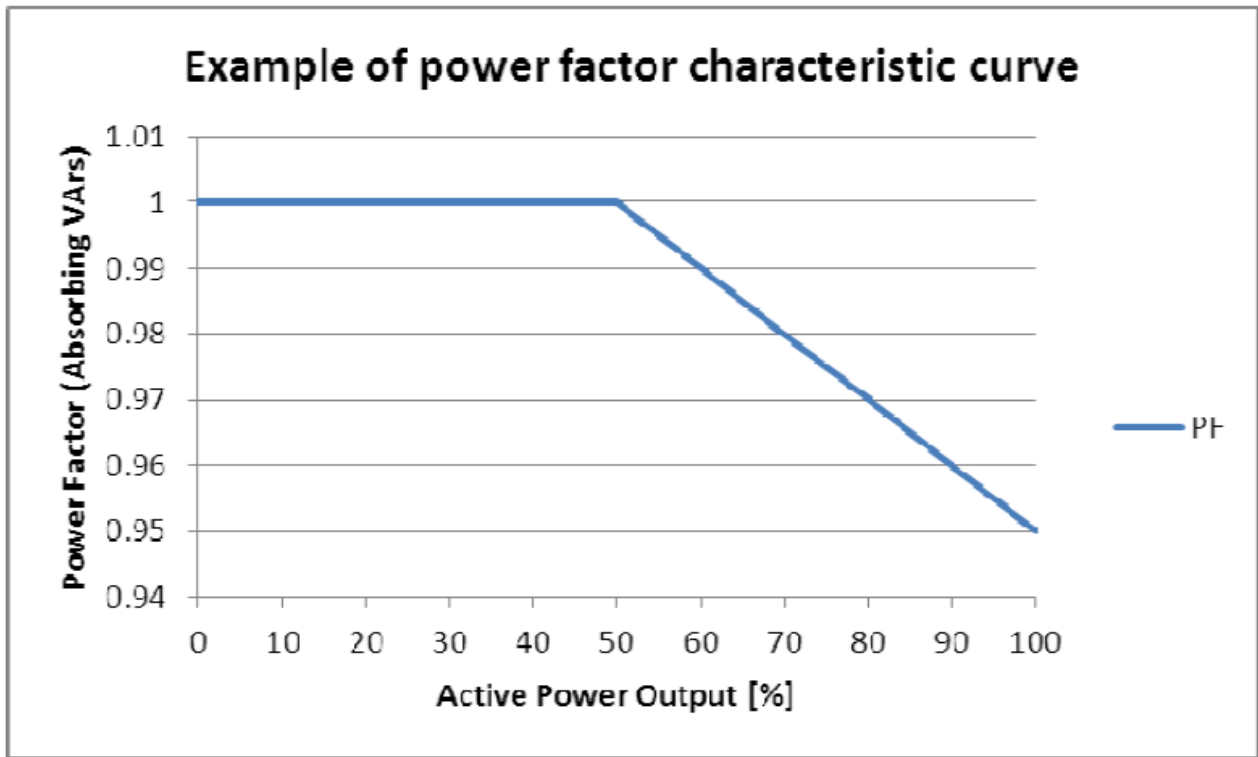

Model: LXP 5K Hybrid

Setting $\cos \phi(P)$ with the standard characteristic curve (20%P_n to 100%P_n)

Active Power Setting (% P _{E_{max}})	Active Power Measured (W)	Reactive Power Measured (Var)	cos ϕ Measured	Desired cos ϕ	Δ cos ϕ (<0,01)	Transient period (<10s)
20	1020.27	100.37	0.9950	1.00	-0.0050	--
30	1530.51	99.70	0.9978	1.00	-0.0022	--
40	2037.58	103.55	0.9987	1.00	-0.0013	--
50	2547.72	-104.97	0.9991	1.00	-0.0009	--
60	3033.81	-429.83	0.9901	0.99	0.0001	--
70	3533.50	-711.13	0.9803	0.98	0.0003	0.25s
80	4025.37	-1020.07	0.9694	0.97	-0.0006	0.25s
90	4515.94	-1356.60	0.9577	0.96	-0.0023	0.25s
100	5008.54	-1645.11	0.9536	0.95	0.0036	0.25s

Graph

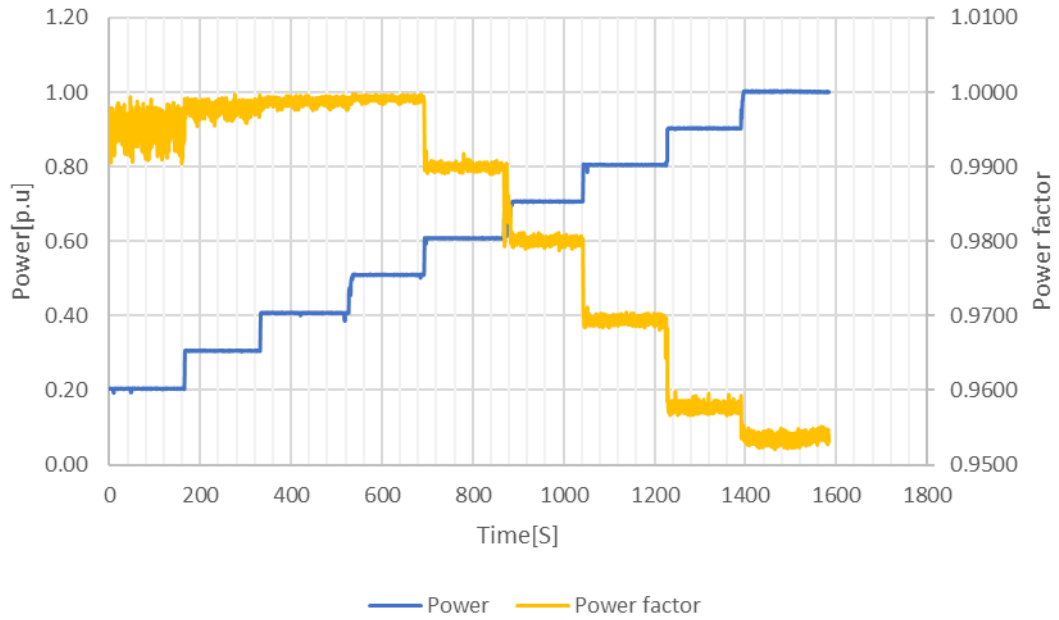

4.2.2.3.2	Table: Overvoltage and undervoltage	P
------------------	--	----------

1	2
Voltage range (at point of connection)	Maximum trip time S
V < 50 %	0,2 s
50 % ≤ V < 85 %	10 s
85 % ≤ V ≤ 110 %	Continuous operation
110 % < V < 115 %	40 s
115% ≤ V < 120%	2 s
120 % ≤ V	0,16 s
<p>NOTE If multi-voltage control settings are not possible, the more stringent trip time should be implemented, e.g. 2 s between 110% and 120% of voltage.</p>	

Voltage level	Voltage Setting (p.u.)	Voltage Trip (p.u.)	Deviation (within ±0.01)	Trip time limit (ms)	Time measured (ms)
U < 50% Un	0.500	0.503	0.003	200	190
U < 85% Un	0.850	0.849	-0.001	10000	9960
U > 110% Un	1.100	1.108	0.008	40000	39940
U > 115% Un	1.150	1.155	0.005	2000	1920
U > 120% Un	1.200	1.203	0.003	160	110

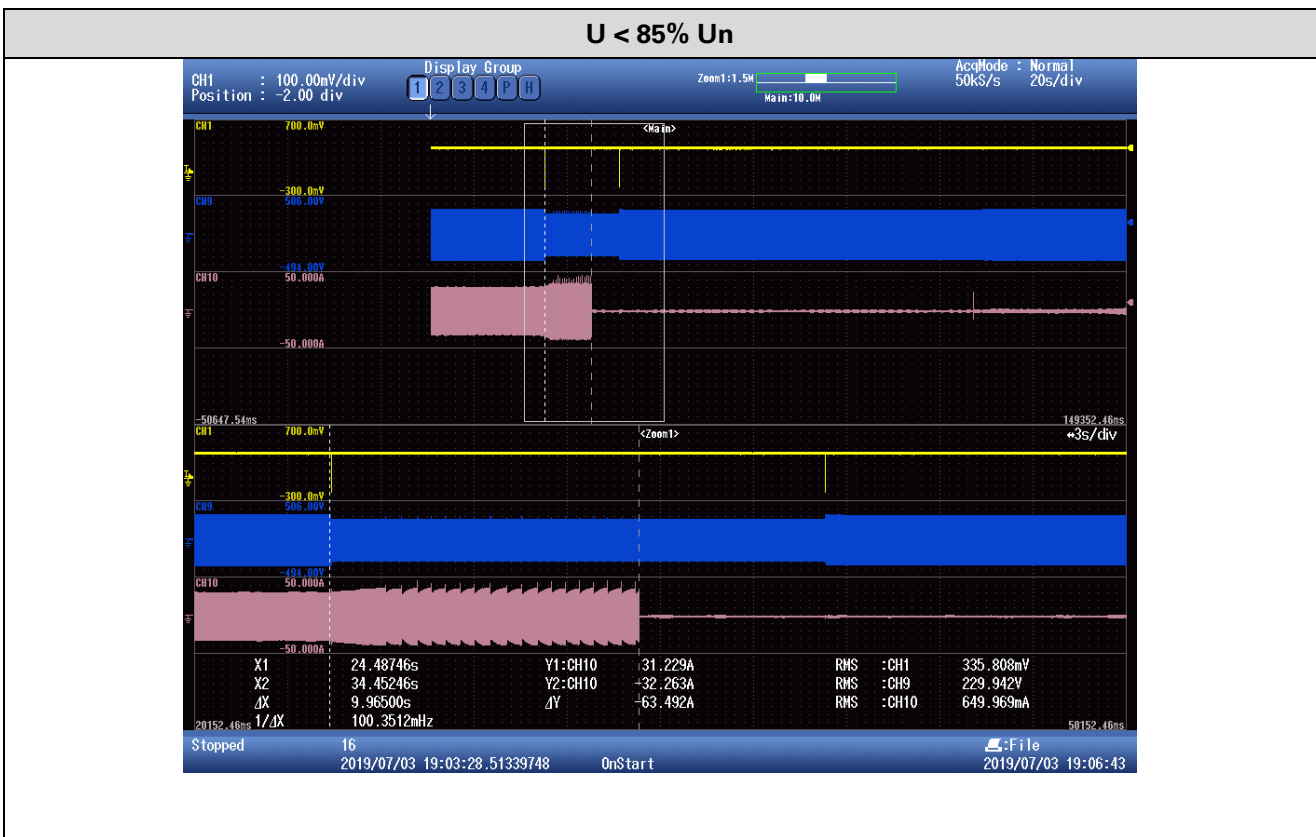
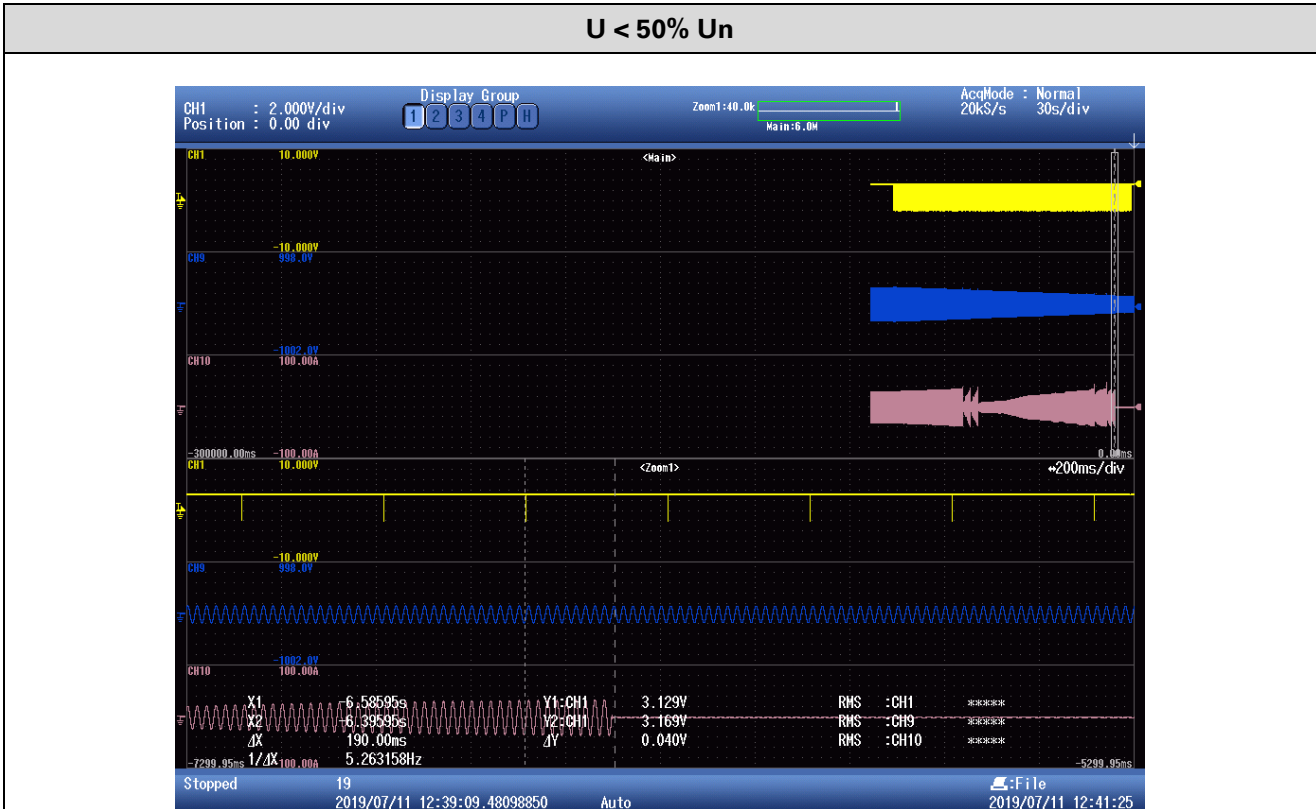

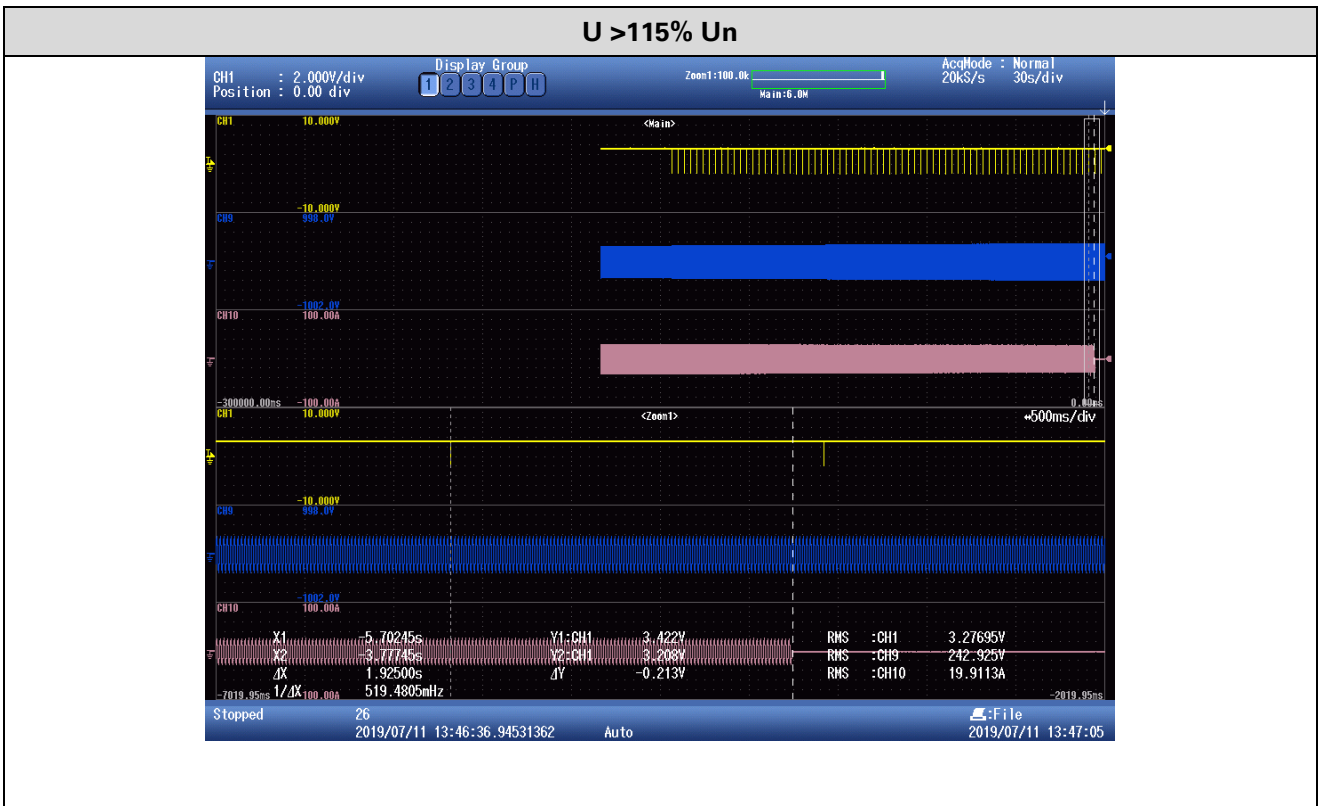
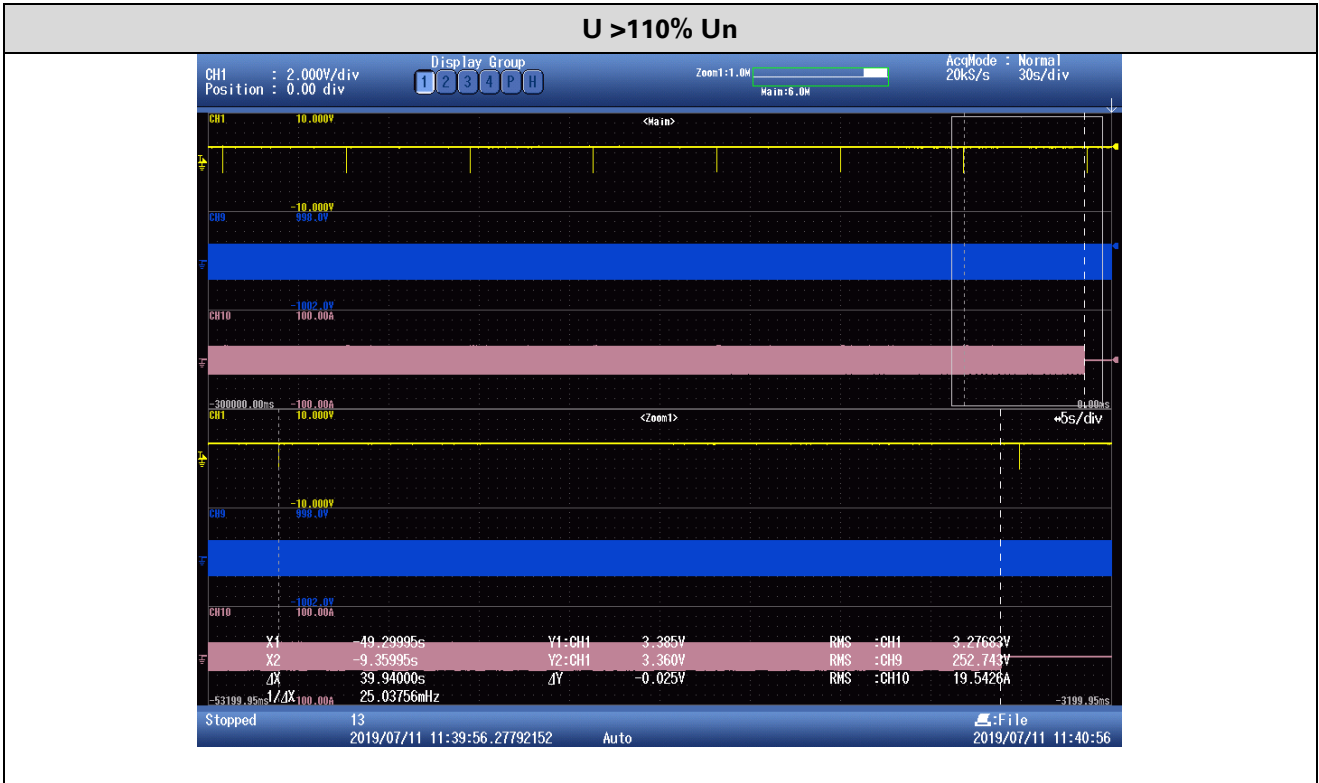

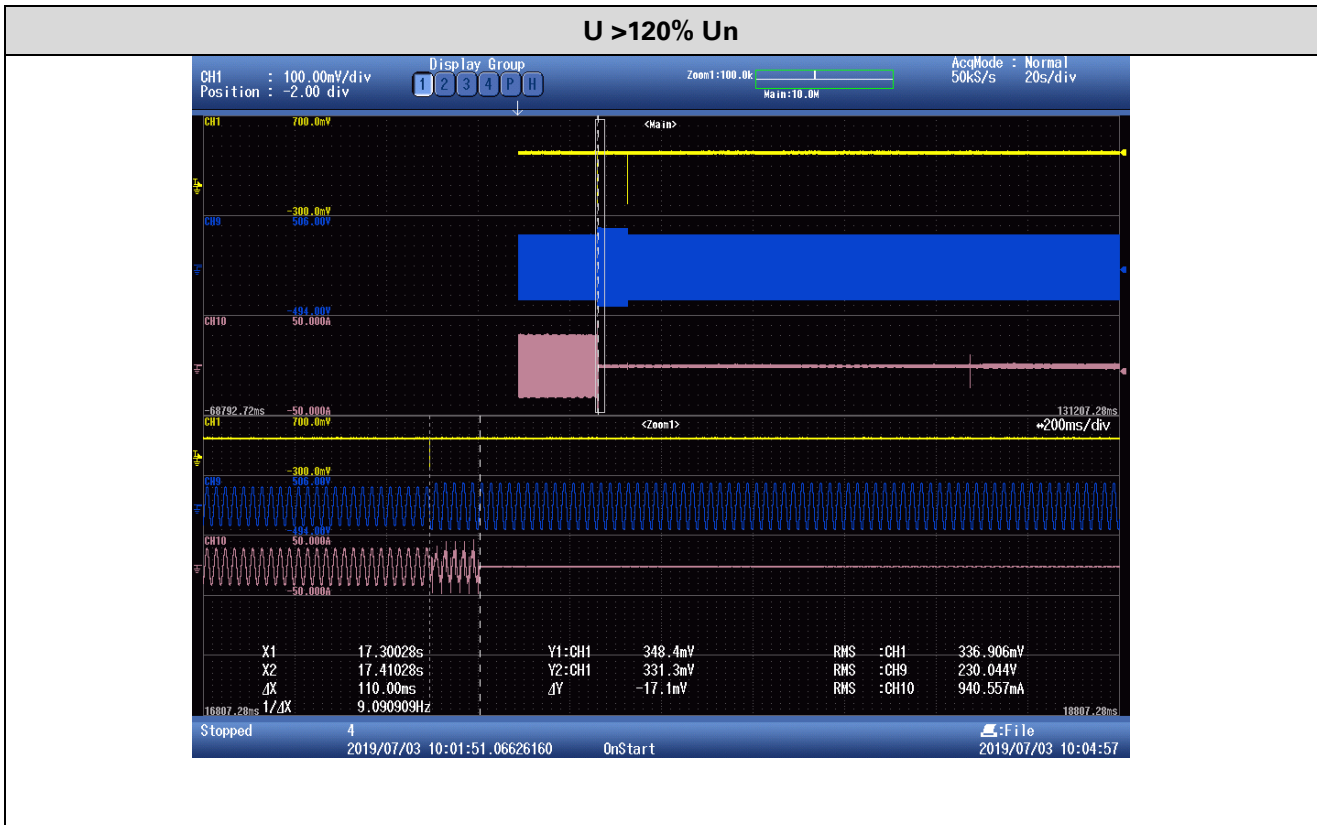

4.2.2.3.3 Table: Overfrequency and underfrequency P

The random disconnect frequency shall be selected so that all generators from any specific manufacturer will disconnect uniformly over the range with 0.1 Hz increments

When the utility frequency is less than 47 Hz, the embedded generator shall disconnect from the utility network within 0.2 s.

When the utility frequency is more than 52 Hz for longer than 4 seconds, the embedded generator shall cease to energise the utility line within 0.5 s.

When the utility frequency exceeds 50.5 Hz, the active power available at the time shall be stored as the maximum power value P_M ; this value P_M shall not be exceeded until the frequency has stabilized below 50.5 Hz for at least 4 seconds

The EG system shall control the output power as a function of P_M at a gradient of 50 % per Hertz as illustrated in figure 5. The power generation shall follow the curve shown in figure 5 up and down while the system frequency is in the range 50.5 Hz to 52 Hz.

Power curtailment during over-frequency

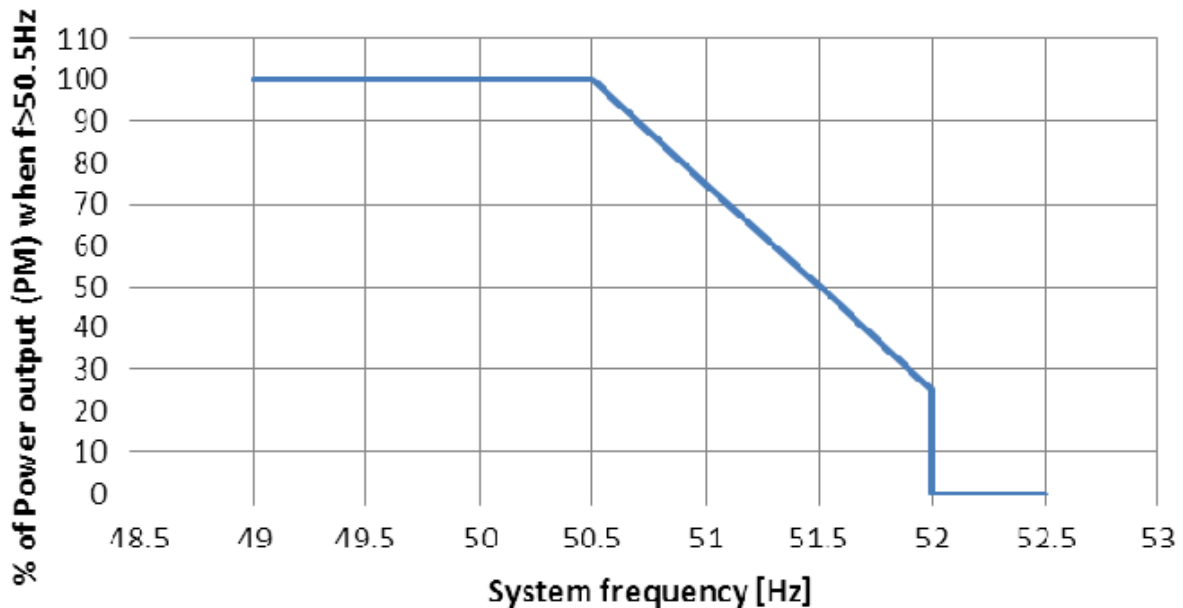

Frequency	Frequency Setting (Hz)	Frequency Trip (Hz)	Deviation (within ± 0.1 Hz)	Trip time limit (s)	Time measured (s)
f < 47Hz	47.00	47.06	0.06	0.2	0.168
f > 52Hz	52.00	52.05	0.05	4.0-4.5	4.150

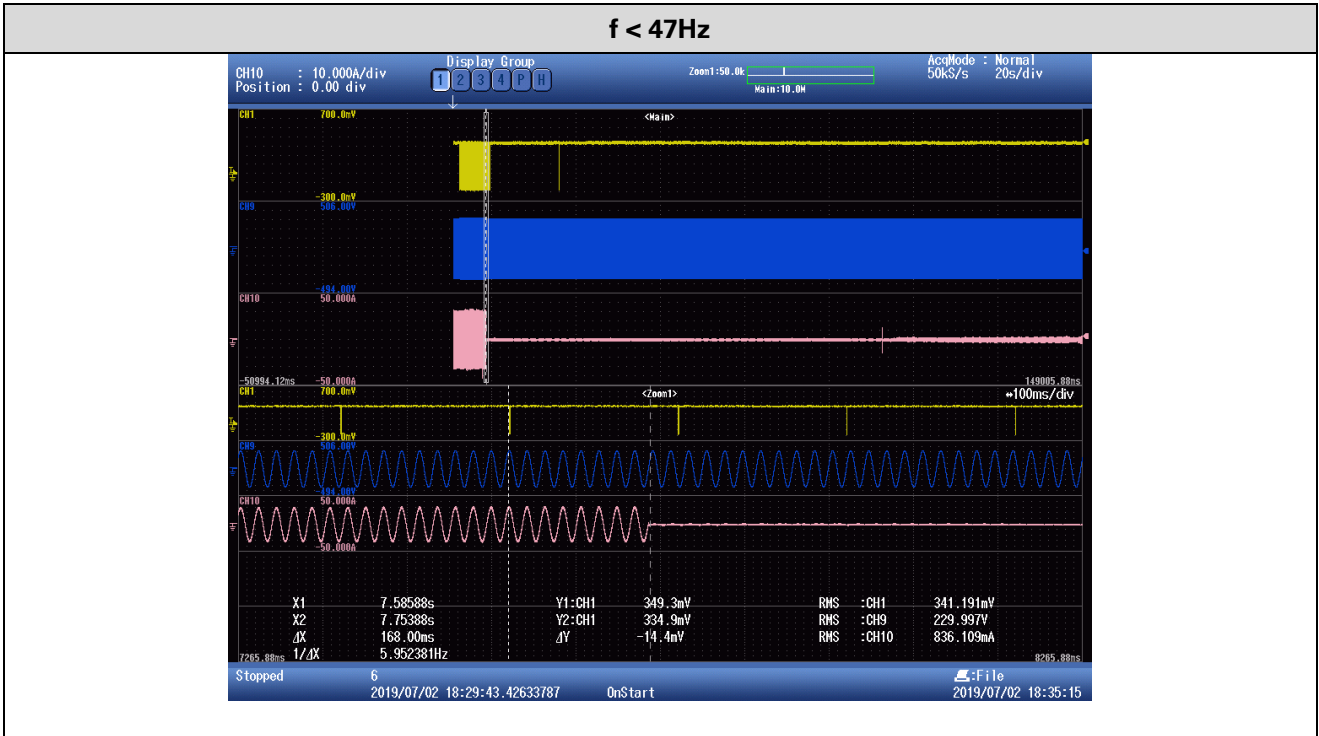

F (Hz)	Frequency Measured (Hz)	P Desired (p.u.)	P Measured (p.u.)	ΔP (p.u.)
49.00	49.00	1.000	1.0053	0.0053
49.50	49.50	1.000	1.0055	0.0055
50.00	50.00	1.000	1.0052	0.0052
50.50	50.50	1.000	1.0019	0.0019
51.00	51.00	0.750	0.7551	0.0051
51.50	51.50	0.500	0.5037	0.0037
52.00	52.00	0.000	-0.0022	-0.0022

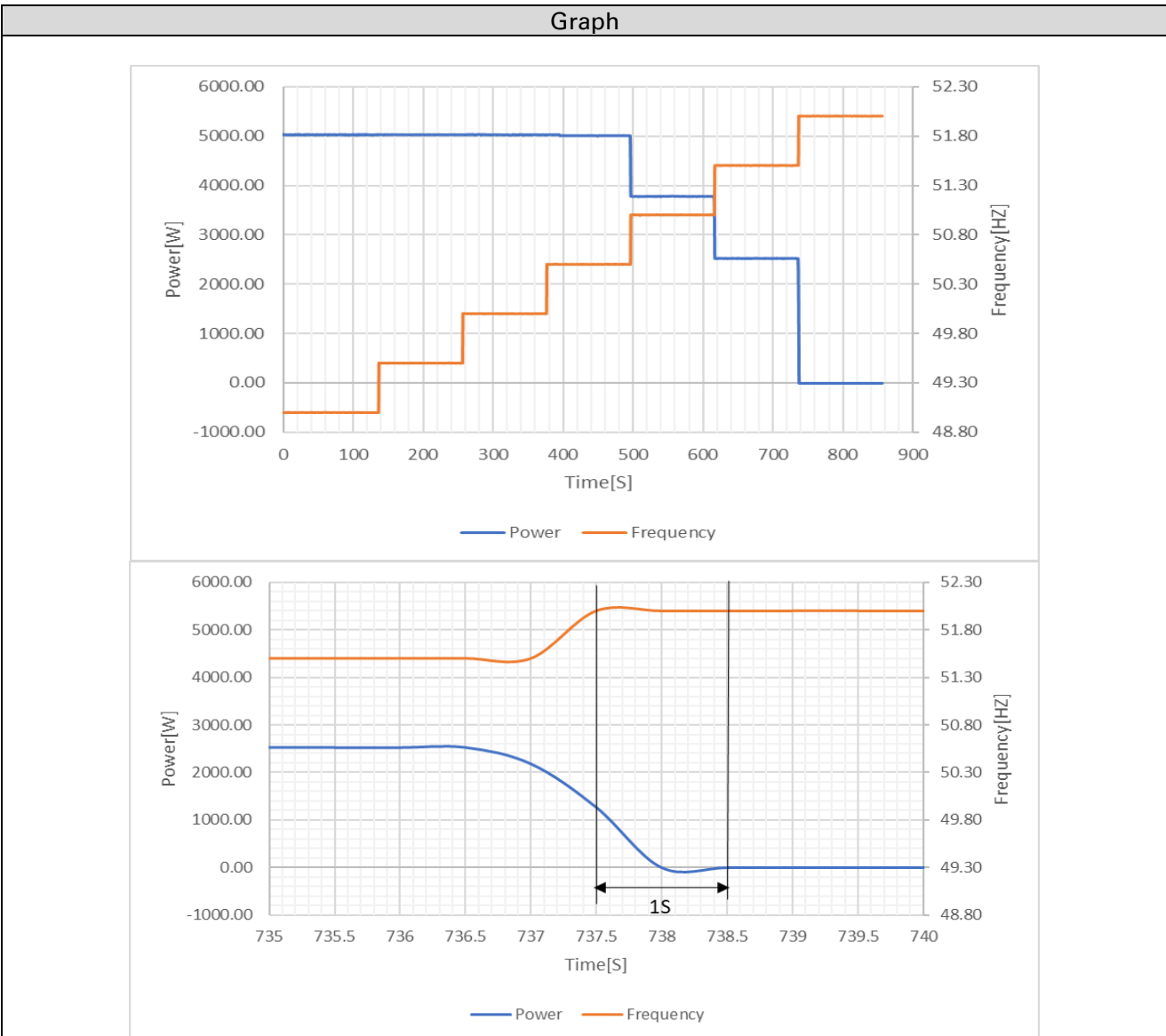

4.1.12 & 4.2.4		Table: Synchronization Response to utility recovery			P
No connection Or Disconnection		Connection after 60 sec		Connection time (s)	Rising curve of 10%Pn/min
U > 110% Un	Yes	85% Un < U < 110 % Un	Yes	113.5	9.98%Pn/min
U < 85% Un	Yes	85% Un < U < 110 % Un	Yes	127.0	9.91%Pn/min
f > 52 Hz	Yes	47.00 Hz < f < 50.5 Hz	Yes	80.5	9.98%Pn/min
f < 47.00 Hz	Yes	47.00Hz < f < 50.5 Hz	Yes	83.0	9.34%Pn/min

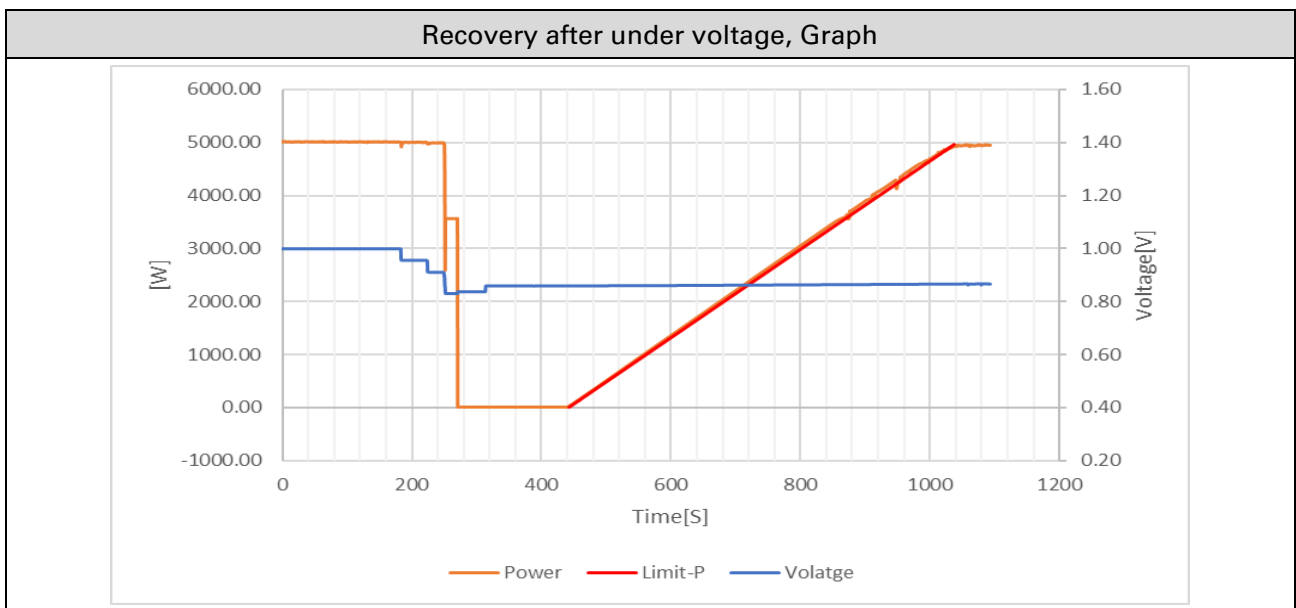
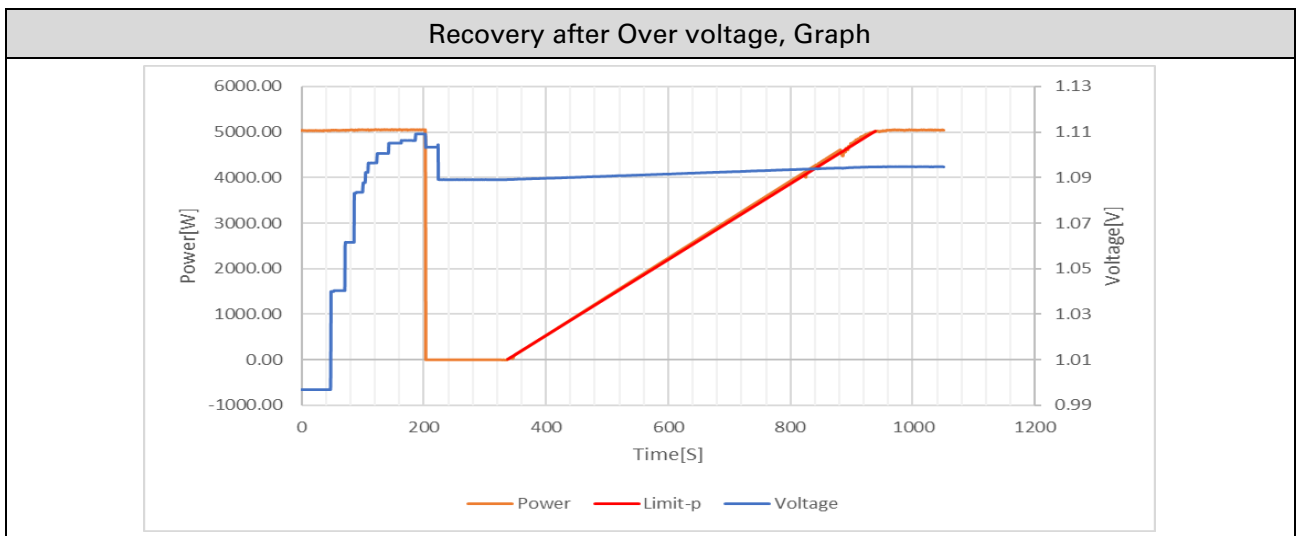

Recovery after Over Frequency, Graph

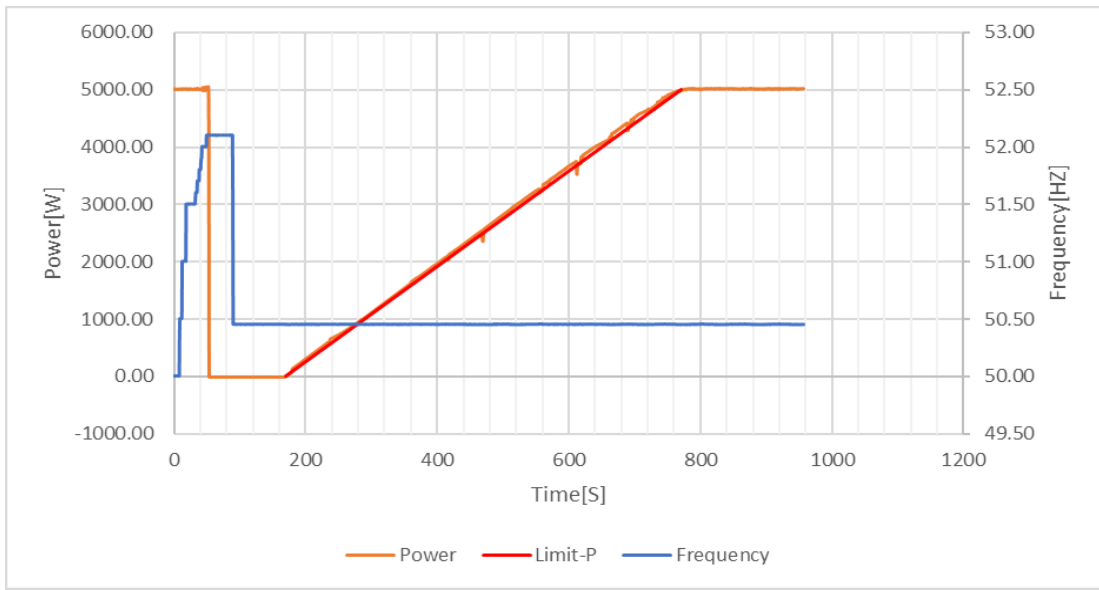

Recovery after under Frequency, Graph

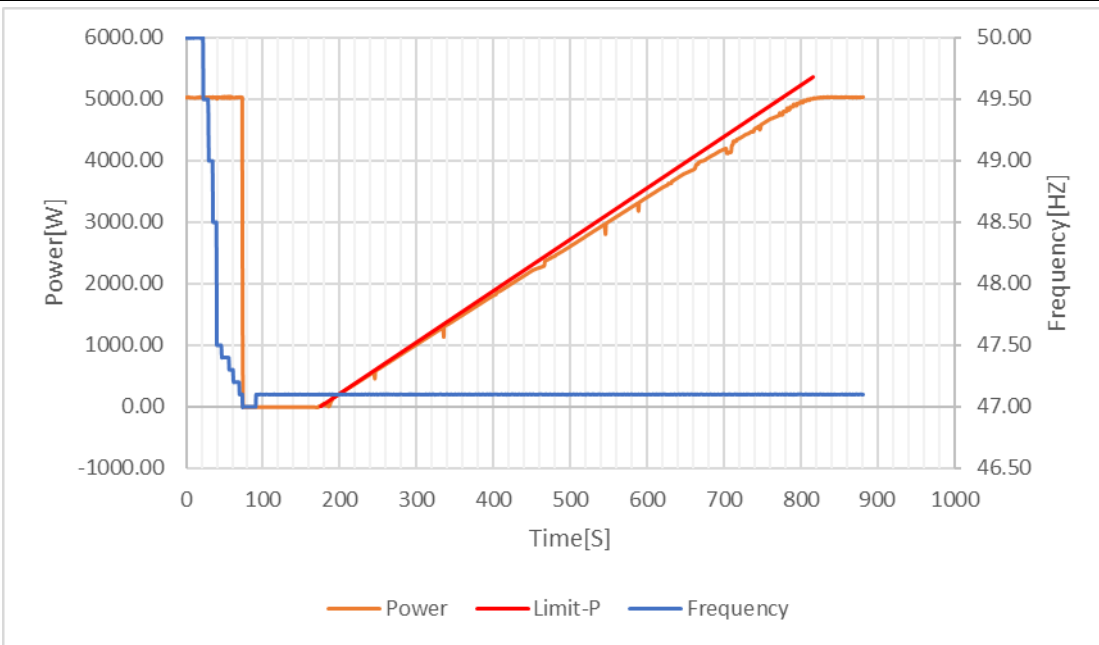

4.2.2.4 Prevention of islanding									P
No.	PEUT ¹⁾ (% of EUT rating)	Reactive load (% of QL in 6.1.d)1)	PAC ²⁾ (% of nominal)	QAC ³⁾ (% of nominal)	Run on time (ms)	PEUT (W)	Actual Qf	VDC	Remarks ⁴⁾
1	100	100	0	0	760	5000	1.0	480	Test A at BL
2	66	66	0	0	530	3300	1.0	350	Test B at BL
3	33	33	0	0	665	1650	1.0	150	Test C at BL
4	100	100	-5	-5	320	5000	0.98	480	Test A at IB
5	100	100	-5	0	366	5000	0.96	480	Test A at IB
6	100	100	-5	5	332	5000	0.95	480	Test A at IB
7	100	100	0	-5	334	5000	1.02	480	Test A at IB
8	100	100	0	5	330	5000	0.97	480	Test A at IB
9	100	100	5	-5	300	5000	1.05	480	Test A at IB
10	100	100	5	0	640	5000	1.05	480	Test A at IB
11	100	100	5	5	252	5000	1.03	480	Test A at IB
12	66	66	0	-5	233	3300	1.02	350	Test B at IB
13	66	66	0	-4	320	3300	1.02	350	Test B at IB
14	66	66	0	-3	322	3300	1.01	350	Test B at IB
15	66	66	0	-2	488	3300	1.01	350	Test B at IB
16	66	66	0	-1	482	3300	1.00	350	Test B at IB
17	66	66	0	1	780	3300	1.00	350	Test B at IB
18	66	66	0	2	572	3300	0.99	350	Test B at IB
19	66	66	0	3	455	3300	0.99	350	Test B at IB
20	66	66	0	4	450	3300	0.98	350	Test B at IB
21	66	66	0	5	290	3300	0.98	350	Test B at IB
22	33	33	0	-5	213	1650	1.03	150	Test C at IB
23	33	33	0	-4	216	1650	1.02	150	Test C at IB
24	33	33	0	-3	218	1650	1.02	150	Test C at IB
25	33	33	0	-2	238	1650	1.01	150	Test C at IB
26	33	33	0	-1	240	1650	1.00	150	Test C at IB
27	33	33	0	1	626	1650	1.00	150	Test C at IB
28	33	33	0	2	618	1650	0.99	150	Test C at IB
29	33	33	0	3	465	1650	0.99	150	Test C at IB
30	33	33	0	4	445	1650	0.98	150	Test C at IB
31	33	33	0	5	322	1650	0.97	150	Test C at IB

Remark:

- 1) PEUT: EUT output power
- 2) PAC: Real power flow at S1 in Figure 1. Positive means power from EUT to utility. Nominal is the 0% test condition value.
- 3) QAC: Reactive power flow at S1 in Figure 1. Positive means power from EUT to utility. Nominal is the 0% test condition value.
- 4) BL: Balance condition, IB: Imbalance condition.
- 5) *Note: test condition A (100%): If any of the recorded run-on times are longer than the one

recorded for the rated balance condition, i.e. test procedure 6.1 f), then the non-shaded parameter combinations (no.32-47) also require testing.



PEUT 100%, PAC 0%, QAC 0%, = 760ms



PEUT 66%, PAC 0%, QAC 1%, = 780ms



PEUT 33%, PAC 0%, QAC 0%, = 665ms

Note: Green denotes current of EUT; Blue denotes current of signal (the signal from Grid), Yellow denotes Voltage of EUT



Overview



Connection view



Backside view



Internal view

(End of Report)